



FF FOX[®]

B E A R I N G S

WHEEL END BEARINGS, HUBS, KITS

R E F E R E N C E S

FOX®

B E A R I N G S



ENGINEERED TO PERFECTION

APPLICATIONS

EUROPEAN & AMERICAN TRUCKS / BUSES & TRAILERS

INDEX

FOX NO.	ALT. BEARING NOS	SUITABLE TO OEM NOS	PAGE NO.
Fx BTH 0018A	201037/571762.H195	1413785/1439070/1413785/1443078	1
	571762.01.H195/VKBA 5314	1476945/2310169/1868087/1365570	
	SET 1231/NP 078914	1476945/1413785/1336296/1382900	
	NP 273671 90U86	1356897	
Fx BTH 0022	VKBA 5412/BTH 0055/VKBA 5552	014985105/0149819305/0149819905	2
	201034/HDS 103/805003A.H195	0179815005/0169812805/219817005	
	SET 1230		
Fx 201050	DU60108-8/SET 1349	0159811905/0149815705	3
Fx 805092C	805092.07/VKBA 5415/VKBA 5418	833202/7182915/7181863/81934200336	4
	NP 79315490UA3/SET 1263	81934200336/81934200379/81934206083	
		81934206099/85103257	
Fx BTH 1011	VKBS 3552/713690840	7180066	5
Fx BTH 0053	NP318274-90UA7/SET 1242	1905487/2996882/7179751/7183074	6
	NP 724254-90UA7/201059	7183075/7189050/7189648/7179749	
	805012.06.H195/VKBA 5397	1408086/1400291	
	BTH 0025		
Fx 201072	NP 493386/VKBA 5413	42537774/42539148/1801594	7
Fx 566283.01.H195	VKBA 5431/SET 1352		8
Fx 803194A	803194.26	0139812205/0139812305/0139819805	9
	VKBA 5415	1703859/7182915/81934200336	
	BTH 0010D	81934200379/8193420683/81934206099	
	NP 793154	8193420612/30030522/85103257/833202	
Fx 805011C	VKBA 5409/BTH 0054/SET 1237	2994058/7184079/7184080	10
	NP4058190UA1		
Fx 201043	HDS 001/HUR 040/579205.H195	5010439770/504189654/20764313	11
	BTF 0045/VKBA 5420/VKBA 5316		
	SET 1350		

INDEX

FOX NO.	ALT. BEARING NOS	SUITABLE TO OEM NOS	PAGE NO.
Fx VKBA 3553	713690850/BTFB 328755D/ VKBA 3553	93810034	12
Fx F-564734.H195	VKBA 5549 BTF 0056EB	1002689/100167600/10067601/10167600 1003457/3200200151/3434365000 4200200100/4200200101	13
FX 805532.01.H195		20518611/20523890	14
Fx 201044	VKBA 5308	5010216920/7420879770	15
Fx 801974AE.H195	BTH 0110/VKBA 5377 BTF 0021A/201012	42541578/5006207845/81934200288 81934200330/81934200349	16
Fx 201042	HDS 002/HUR 056	5010566154/7421190412/21190412	17
Fx 201082	VKBA 5411/BTF 0074A/SET 1337	81934200337	18
Fx 805531/165	VKBA 5407/BTF 0068	5010587029/20550678/85124433	19
Fx 566283.H195	505208W/805008C/805052C VKBA 5431	1801594/1812161/1818003	20
Fx 803904	503809	3434301200/4373004400/5387001105 4200101602/4373004300/5387001503 3434301200/17234877/881002	21
Fx F-566425.H195	VKBA 5423 SET 1314 800792D HDS 219	7420819860/7420819846/5001861915 7420535262/7420535264/7420792439 7420819859/7420819834/2277946 792439/20964828/21036050/20518661 1075408/20792440	22
Fx F-570530.H195	808918/SET 1370	343401900/3434302000/320010200	23
Fx F-566193.H195	579065D	1801593/3434200101500/16105276	24

INDEX

FOX NO.	ALT. BEARING NOS	SUITABLE TO OEM NOS	PAGE NO.
Fx F-566834.H195	SET 1351/VKBA 5429	1801595	25
Fx F-566074.H195	VKBA 5453/SET 1346	1801592/16911621/1699327/1818004	26
Fx F-566427.H195	805165	7420518617/742102181/7421022434	27
	VKBA 5424	7421024188/2051861/2208157	
	SET 1311	20967830/20589393/20589394/21021381	
Fx 201009	BT1B328251/VKHB 2240	6324990103/6324990104/6324890072	28
	201075	6324890073	
Fx 581079C	566426.H195	3988674/3988675/20382168/20518092	29
	VKBA 5425	20518093/20518637/20558950/20581399	
	SET 2312	20728008/20967831/1075408/20792440	
		7420535203/7421024206/7420518637	
		7420535202/7421021391/7421024208	
		7420967831	
Fx 803750 B	VKBA 5408/BT2013OA	36934200009/503126457/81934200376	30
	HDS 220/SET 1335	81934200320/81934200342/503126457	
Fx 566830.H195		04200101602/03434301000/03434301200	31
Fx 569868.H195		3434301800/04200101900	32
Fx 804162 A	VKBA 5416	81934200346/81934206098	33
Fx VKBA 2451		0980107340/0264102300S	34
Fx VKBA 2451	VKBA 5551	0980106270	34
Fx VKBA 5521		0980102720/0980102330/0264065000	35
		723700110	
Fx VKBA 2421		0980102720	35

INDEX

FOX NO.	ALT. BEARING NOS	SUITABLE TO OEM NOS	PAGE NO.
Fx VKBA 5522	VKBA 2422	0980102340/0264076500/723700510	36
Fx VKHB 2029	VKHB 2051 VKHB 5507 VKHB 2405S	184672/06324890046/0264076500 264102200	36
Fx VKBA 5527		0980102340	37
Fx VKBA 5524		0980102980	37
Fx VKBA 2425	723700110/VKBA 5525	0980102190	38
Fx VKBA 5526		0980102200	38
Fx VKBA 5560	VKBA 2450	0980106260	39
Fx 11-102170		0980102170	39
Fx 11-102180	33218/33213	0980102180	40
			40
Fx 01-503835		942 350 3835	41
Fx 01-502735		000 350 2735	41
Fx 01-01835		940 350 1835	42
Fx 40-00600S		4200100600 S	42
Fx 40-362300		3434362300	43
Fx 40-301600		3434301600	43
Fx 06-70075S		370075 S	44
Fx 06-04500S		1104500 S	44
Fx 06-735498		1735498	45
Fx 06-40992S		1740992 S	45

INDEX

FOX NO.	ALT. BEARING NOS	SUITABLE TO OEM NOS	PAGE NO.
Fx 06-550905		550905	46
Fx 11-106260		0980106260	46
Fx 11-02400S		0264102400 S	47
Fx 11-02300S		0264102300 S	47
Fx 11-102200		0980102200	48
Fx 11-102980		0980102980	48
Fx 01-561101		9773561101/9763560701	49
Fx-01-341201		9423341201/9423340701/9423340201 9423341501/9423340201/9493340801	50
Fx-560201		9463560201	51
Fx-1010101		3560101101/9463560101/9463561301	52
Fx 01-563601		3553563601/6173560501/3553563901 3553563501/3463560401	53
Fx 01-567001		3713567001/3713560001	54
Fx 01-341401		9423341401/9423340301	54
Fx 01-560801		3463560801/3463563001/3463562001 3463562301	55
Fx 01-562101		3463561401/3463562401/3463562101 6253560101/346356001/3463560001	56
Fx 01-560601		3853560601/3853561401	57

INDEX

FOX NO.	ALT. BEARING NOS	SUITABLE TO OEM NOS	PAGE NO.
Fx 01-340601		3873340601	58
Fx 01-435160		4472435160/0003560401/9463560501 9463560401/0003500535/9463560401	58
Fx 01-340201		3563340201/3563340001	59
Fx-560001		3563560001	60
Fx 01-300725		0003300725/9433340945	60
Fx 01-560701		9463560701/4003560701	61
Fx 01-562901		3463562901/3463562801/9423561701	62
Fx 01-500535		0003500535/9463560501/9463560401	63
Fx 41-435370		4472435370/4472433570/4474335074 4472435370/4474435370	64
Fx 01-340145		9703340145/9703340045	64
Fx 01-340701		9433340701/9433301125	65
Fx 01-340345		9703340345/9723300525/9723300125 9723300225/9703340344/9723300325 9723300425/9723300625/9703300144	66
Fx 01-300825		9433300825	67
Fx 01-560801		9423560801/9423560001	68
Fx 01-561301		9423561301	69
Fx 41-385118		4474385118	69
Fx 01-560901		9423560901	70

INDEX

FOX NO.	ALT. BEARING NOS	SUITABLE TO OEM NOS	PAGE NO.
Fx 01-301125		9433301125/9433340701	71
Fx 01-340301		9423340301/9423341401	72
Fx 01-300335		9463300335/9703500335/9703560301	72
Fx 01-300425		9753300425/9753300825	73
Fx 01-301225		9433301225/943330125/0003300725	74
Fx 01-561801		9763561801/9763561101/9763560701 9754230112	75
Fx 01-560301		6153560301/3853560801/3853561301	75
Fx 01-562401		3463562401	76
Fx 01-340101		6233340101/6233340001/6233341401 3073340401	77
Fx 01-340101		6553340101/6553340001/3893341501	78
Fx 01-340001		6283340001/6283340301/3573340301	78
Fx 01-340301		4003340301/6243340301/6243340201 6263341001	79
Fx 01-340601		3893340601/6243340001/3893341401 6243340401/6243340501/6243340101	80
Fx 01-340501		3553340501/3853340601/3853341001 3853341101	81
Fx 01-560101		3853560101/3453560101/3853561001 3853561101	82
Fx 01-560401		3023560401	82

INDEX

FOX NO.	ALT. BEARING NOS	SUITABLE TO OEM NOS	PAGE NO.
Fx 01-562501		3463562501	83
Fx 01-563101		3463563101	84
Fx 01-560701		9463560701	85
Fx 01-501235		0003501235/4472336309/ZF 4474335121 ZF 4473755725/4474335169	86
Fx 01-502335		0003502335/9463562601/0003500535 JAE0250302801	86
Fx 01-560301		6683560301/6683500035	87
Fx 41-435370		4472435370/4472433570	87
Fx 01-500635		0003500635/4472435376/9493340501 9493340801	88
Fx 01-511303		31511303	88
Fx 40-205600		3307205600/3307300700	89
Fx 40-300310		1307300310	90
Fx 40-300600		3307300600/3307300601/3307300300 1307104213/1307970822/1307300614 3307301200	91
Fx 40-104200		2307104200/2307104212/2307106000 2307106300/23010421200	92
Fx 40-105400		2307105400	93
Fx 40-302510		1307302510/3307302501	93

INDEX

FOX NO.	ALT. BEARING NOS	SUITABLE TO OEM NOS	PAGE NO.
Fx 40-105510		1307105510	94
Fx 40-200100		01146200100/01146200401/1146200402	94
Fx 40-303000		3307303000/3307303001/1307304310	95
Fx 40-306610		1307306610/3307305600/3307305601 330735603	95
Fx 40-304301		3307304301/3307304300/3307304302 13073043010	96
Fx 40-711660		3307116600/1307116600	97
Fx 41-106800		1307106800/650275D/0018321C	98
Fx 40-112901		1307112901/1307112900/1307112711	98
Fx 40-304600		3307304600/3307304601	99
Fx 40-116600		3307116600/3307116601	100
Fx 40-205600		3307205600/3307300700	101
Fx 40-304500		3307304500/3307304501/3307304502	101
Fx 11-227200		0327227200	102
Fx 11-227410		0327227410/0980106500 S1	102
Fx 11-227480		0327227480/0980106540 S	103
Fx 11-244210		0327244210/0327244300/0327244170	103
Fx 11-244240		0327244240/0327227200/0327244210 0327248320/9763561101/9463560201 3463560301/6233340001/8335701052 81443013146/81357013128/81357013152	104

INDEX

FOX NO.	ALT. BEARING NOS	SUITABLE TO OEM NOS	PAGE NO.
Fx 11-244340		0327244340/0980106520 S	105
Fx 11-244400		0327244400/0980106560 S	105
Fx 11-228560		0327228560	106
Fx 11-243140		0327243140/0327243141/0327243142 0980106580/03272431602	106
Fx 11-230990		0327230990/0327230990 S	107
Fx 11-243280		0127243280/098107320/0327243280 0980107320 S	107
Fx 11-246110		0327246110	108
Fx 11-230310		0327230310/0327230190	108
Fx 11-230340		0327230340/0327230350/0327230620 0327230410	109
Fx 11-230810		0327230810	110
Fx 11-230950		0327230950/0327230970/0980106050 S	110
Fx 11-230410		0327230410/0327230620/0327230350	111
Fx 11-230300		0327230300/0327230070/0327230050 0327230380/8241000482	112
Fx 11-230870		0327230870/0327230810/0980106030	112
Fx 11-248460		0327248460/0327248400/0327248620 0327248450/0327248390	113
Fx 11-248320		0327248320/0BP327248070/0327248100 0327248120	114

INDEX

FOX NO.	ALT. BEARING NOS	SUITABLE TO OEM NOS	PAGE NO.
Fx 11-243100		0327243100/0327243102 S	115
		0980106070 S	
Fx 11-232050		0327232050/0327232050 S	116
Fx 11-248780		0327248780/0980106040/0980106720	116
Fx 11-243120		0327243120/0980106060/0327243232	117
		0980106082	
Fx 11-243200		0327243200/0327248780/0980106040 S	117
		0980106720 S	
Fx 11-248330		0327248330/0327248170/0327248350	118
Fx 11-248520		0327248520	119
Fx 11-262270		0327262270/0327262190/0327262200	120
Fx 11-248970		0327248970/0327243120/0327248950	120
		0980106060/0327243232/0980106082	
Fx 11-280860		0327280860/0327280060/0327280070	121
		0327280180/0327280100/0327280190	
		0327286100/0327280140	
Fx 11-262350		0327262350	122
Fx 11-247330		0327247330/0980106130 S/0980106140 S	122
Fx 11-243290		0327243290	123
Fx 11-243222		0327243222	124
11-246330		0327246330	124

INDEX

FOX NO.	ALT. BEARING NOS	SUITABLE TO OEM NOS	PAGE NO.
Fx 11-248970		0327248970	125
Fx 11-246280		0327246280/0980106690 S/0327246282	125
Fx 11-243262		0327243262	126
Fx 11-246302		0327246302	126
Fx 11-262350		0327262350	127
Fx 11-263060		0327263060/0327263080/0327263120	127
Fx 11-228350		0327228350	128
Fx 06-868663		1868663/1480933/1724406/1391369 1866430	129
Fx 06-800283		1800283/1382884	130
Fx 06-724790		1724790	131
Fx 06-379188		379188/397186/562051	132
Fx 06-868674		1868674/1414154/1382774/1371596 1724407	133
Fx 06-337565		337565/255348/347945/255348/1724788	134
Fx 06-337563		337563	135
Fx 16-626994		1626994/20374418	136
Fx 16-535207		20535207/20819804/1075408/20820402 1075428/1076526/7420819806 7421328181	137
Fx 16-024160		21024160/21024166/20518092/20534905 74535202/7420534904/74210214160	138

INDEX

FOX NO.	ALT. BEARING NOS	SUITABLE TO OEM NOS	PAGE NO.
Fx 16-988930		3988930/85114471/85111794/3989341	139
		8510818/85105693	
Fx 16-026798		1026798/20252417/20535202/85107750	140
		85111448/8514470/85111791/21024206	
		7420535202/7421024206/7421116569	
		7485114470	
Fx 16-516966		20516966/20535263/85107753	141
		85105696/3092720/85104298	
Fx 16-517164		20517164/1078053/85104301	142
Fx 16-111792		85111792/85105692	143
Fx 16-943982		3943982/20476519/20518054/20517950	144
		20517952	
Fx 16-518092		20518092/21024155	145
Fx 08-724407		1724407/1414154	146
Fx 08-CT1106		98CT1106/RFC1106AB	147
Fx 16-819804		20819804/1075408/20820402/1075428	148
		21328177/21328181/20535207	
		7421328181/7420819806	
Fx 30-566112		5010566112/5000682333	149
Fx 30-021381		7421021381/7410241087	150
Fx 30-241087		5010241087	150
Fx 30-517167		7420517167/1026661/5001861915	151
Fx 30-022433		7421022433/7485111789/85107749	152
		85111789	

INDEX

FOX NO.	ALT. BEARING NOS	SUITABLE TO OEM NOS	PAGE NO.
Fx 42-038001		AJB 0038001/CF-1014228/448057	153
Fx 42-006077		M006077/CF103079	153
Fx 42-007851		M007851/CF1031007	154
Fx 42-02795D		6502795D/0018321C	154
Fx 42-031007		CF1031007/M006050/449557 449629/M007851	155
Fx 22-010169		81443010169/81443013156/81443010174	156
Fx 22-010155		81357010155/81357013155	157
Fx 22-010141		81357010141/81357010086	158
Fx 22-010182		81443010182	159
Fx 22-013147		81357013147/81357010147	159
Fx 22-006150		81357006150/81357013174/81357006136 81357010174	160
Fx 22-010111		81357010111/81357010159/81357010142	161
Fx 22-010126		81357010126/81357010140/81357013126	161
Fx 22-010000		83443010000/81443010107 9013022181369	162
Fx 22-010004		83357010004/81357010081 81357010128/81357010028	162
Fx 22-010146		81443010146/81443013146	163

INDEX

FOX NO.	ALT. BEARING NOS	SUITABLE TO OEM NOS	PAGE NO.
Fx 22-010142		81357010142/81357010159/81357013111	164
		81357010111/8135701015/8135701041	
Fx 22-300182		8144300182	164
Fx 22-013159		81443013159/81443010159	165
		81443010179/81443011759	
Fx 22-013152		81357013152/81357010151ZF	165
Fx 22-013128		81357013128	166
Fx 22-010161		81357010161	166
Fx 22-570101		81357010176/81357016040	167
		4474335121/36357010000	
Fx 22-010195		81443010195/81443010177	168
Fx 22-010178		81443010178	168
Fx 22-010165		81357010165	169
Fx 22-010176		81443010176/81443013176	170
Fx 37-203219		21203219/14203219	171
Fx 37-226120		21226120	171
Fx 37-204561		21204561/21204562/14204561/14204562	172
Fx 37-228120		21228120	173
Fx 37-225425		14225425	173
Fx 37-226120		14226120	174

INDEX

FOX NO.	ALT. BEARING NOS	SUITABLE TO OEM NOS	PAGE NO.
Fx 37-210885		21210885 R/14210885	175
Fx 37-227483		14227483/21227483	175
Fx 37-225290		21225290/14225290	176
Fx 37-219784		14219784/212211625 21219784/21220158	176
Fx 36-168364		7168364/4685285	177
Fx 36-168365		7168365/4686447	177
Fx 36-168588		7168588/7169999/7162807/7168587	178
Fx 36-179929		7179929/7168464/7181782/7178829	178
Fx 36-172551		7172551	179
Fx 36-173327		7173327/7182031/1782032/7173326	179
Fx 36-104691		42104691/42104692	180
Fx 36-180909		7180909/7179742/2996882	181
Fx 36-183906		7183906/7180797/7188706	182
Fx 36-168593		7168593	182
Fx 36-733114		71733114/7173316/7173315	183
Fx 36-173696		7173696	183
Fx 36-101361		42101361/42037491/42101959/42101918	184
Fx 36-037492		42037492	184

FOX to OEM NOS



INDEX

FOX NO.	ALT. BEARING NOS	SUITABLE TO OEM NOS	PAGE NO.
Fx 36-186803		7186803	185
Fx 36-779775		71779775/7179777/7186804	185
Fx 36-182046		7182046/7172885	186
Fx 36-172993		7172993	186
Fx 36-VKBA3553		93824579/93810034/93824580 VKBA3553/7136908	187
Fx 36-1150156		42115016	187
Fx 36-VKBA3553		709317876/09317876 9272681/9272778 GI09226008/709226008 708606072	188
Fx 06-817256	VKBA 5456	1817256/2117621	189

OEM to FOX NOS



INDEX

SUITABLE TO OEM NOS	FOX NO.	ALT. BEARING NOS	PAGE NO.
1413785/1439070/1413785/1443078	Fx BTH 0018A	201037/571762.H195	1
1476945/2310169/1868087/1365570		571762.01.H195/VKBA 5314	
1476945/1413785/1336296/1382900		SET 1231/NP 078914	
1356897		NP 273671 90U86	
014985105/0149819305/0149819905	Fx BTH 0022	VKBA 5412/BTH 0055/VKBA 5552	2
0179815005/0169812805/219817005		201034/HDS 103/805003A.H195	
9272681/9272778		SET 1230	
0159811905/0149815705	Fx 201050	DU60108-8/SET 1349	3
833202/7182915/7181863/81934200336	Fx 805092C	805092.07/VKBA 5415/VKBA 5418	4
81934200336/81934200379/81934206083		NP 79315490UA3/SET 1263	
81934206099/85103257			
7180066	Fx BTH 1011	VKBS 3552/713690840	5
1905487/2996882/7179751/7183074	Fx BTH 0053	NP318274-90UA7/SET 1242	6
7183075/7189050/7189648/7179749		NP 724254-90UA7/201059	
1408086/1400291		805012.06.H195/VKBA 5397	
		BTH 0025	
42537774/42539148/1801594	Fx 201072	NP 493386/VKBA 5413	7
	Fx 566283.01.H195	VKBA 5431/SET 1352	8
0139812205/0139812305/0139819805	Fx 803194A	803194.26	9
1703859/7182915/81934200336		VKBA 5415	
81934200379/8193420683/81934206099		BTH 0010D	
8193420612/30030522/85103257/833202		NP 793154	
2994058/7184079/7184080	Fx 805011C	VKBA 5409/BTH 0054/SET 1237	10
		NP4058190UA1	
5010439770/504189654/20764313	Fx 201043	HDS 001/HUR 040/579205.H195	11
		BTF 0045/VKBA 5420/VKBA 5316	
		SET 1350	

OEM to FOX NOS



INDEX

SUITABLE TO OEM NOS	FOX NO.	ALT. BEARING NOS	PAGE NO.
93810034	Fx VKBA 3553	713690850/BTFB 328755D/ VKBA 3553	12
1002689/100167600/10067601/10167600	Fx F-564734.H195	VKBA 5549	13
1003457/3200200151/3434365000		BTF 0056EB	
4200200100/4200200101			
20518611/20523890	FX 805532.01.H195		14
5010216920/7420879770	Fx 201044	VKBA 5308	15
42541578/5006207845/81934200288	Fx 801974AE.H195	BTH 0110/VKBA 5377	16
81934200330/81934200349		BTF 0021A/201012	
5010566154/7421190412/21190412	Fx 201042	HDS 002/HUR 056	17
81934200337	Fx 201082	VKBA 5411/BTF 0074A/SET 1337	18
5010587029/20550678/85124433	Fx 805531/165	VKBA 5407/BTF 0068	19
1801594/1812161/1818003	Fx 566283.H195	505208W/805008C/805052C VKBA 5431	20
3434301200/4373004400/5387001105	Fx 803904	503809	21
4200101602/4373004300/5387001503			
3434301200/17234877/881002			
7420819860/7420819846/5001861915	Fx F-566425.H195	VKBA 5423	22
7420535262/7420535264/7420792439		SET 1314	
7420819859/7420819834/2277946		800792D	
792439/20964828/21036050/20518661		HDS 219	
1075408/20792440			
343401900/3434302000/320010200	Fx F-570530.H195	808918/SET 1370	23
1801593/3434200101500/16105276	Fx F-566193.H195	579065D	24

INDEX

SUITABLE TO OEM NOS	FOX NO.	ALT. BEARING NOS	PAGE NO.
1801595	Fx F-566834.H195	SET 1351/VKBA 5429	25
1801592/16911621/1699327/1818004	Fx F-566074.H195	VKBA 5453/SET 1346	26
7420518617/742102181/7421022434	Fx F-566427.H195	805165	27
7421024188/2051861/2208157		VKBA 5424	
20967830/20589393/20589394/21021381		SET 1311	
6324990103/6324990104/6324890072	Fx 201009	BT1B328251/VKHB 2240	28
6324890073		201075	
3988674/3988675/20382168/20518092	Fx 581079C	566426.H195	29
20518093/20518637/20558950/20581399		VKBA 5425	
20728008/20967831/1075408/20792440		SET 2312	
7420535203/7421024206/7420518637			
7420535202/7421021391/7421024208			
7420967831			
36934200009/503126457/81934200376	Fx 803750 B	VKBA 5408/BT20130A	30
81934200320/81934200342/503126457		HDS 220/SET 1335	
04200101602/03434301000/03434301200	Fx 566830.H195		31
3434301800/04200101900	Fx 569868.H195		32
81934200346/81934206098	Fx 804162 A	VKBA 5416	33
0980107340/0264102300S	Fx VKBA 2451		34
0980106270	Fx VKBA 2451	VKBA 5551	34
0980102720/0980102330/0264065000	Fx VKBA 5521		35
723700110			
0980102720	Fx VKBA 2421		35

INDEX

SUITABLE TO OEM NOS	FOX NO.	ALT. BEARING NOS	PAGE NO.
0980102340/0264076500/723700510	Fx VKBA 5522	VKBA 2422	36
184672/06324890046/0264076500	Fx VKHB 2029	VKHB 2051 VKHB 5507	36
264102200		VKHB 2405S	
0980102340	Fx VKBA 5527		37
0980102980	Fx VKBA 5524		37
0980102190	Fx VKBA 2425	723700110/VKBA 5525	38
0980102200	Fx VKBA 5526		38
0980106260	Fx VKBA 5560	VKBA 2450	39
0980102170	Fx 11-102170		39
0980102180	Fx 11-102180	33218/33213	40
			40
942 350 3835	Fx 01-503835		41
000 350 2735	Fx 01-502735		41
940 350 1835	Fx 01-01835		42
4200100600 S	Fx 40-00600S		42
3434362300	Fx 40-362300		43
3434301600	Fx 40-301600		43
370075 S	Fx 06-70075S		44
1104500 S	Fx 06-04500S		44
1735498	Fx 06-735498		45
1740992 S	Fx 06-40992S		45

INDEX

SUITABLE TO OEM NOS	FOX NO.	ALT. BEARING NOS	PAGE NO.
550905	Fx 06-550905		46
0980106260	Fx 11-106260		46
0264102400 S	Fx 11-02400S		47
0264102300 S	Fx 11-02300S		47
0980102200	Fx 11-102200		48
0980102980	Fx 11-102980		48
9773561101/9763560701	Fx 01-561101		49
9423341201/9423340701/9423340201 9423341501/9423340201/9493340801	Fx-01-341201		50
9463560201	Fx-560201		51
3560101101/9463560101/9463561301	Fx-1010101		52
3553563601/6173560501/3553563901 3553563501/3463560401	Fx 01-563601		53
3713567001/3713560001	Fx 01-567001		54
9423341401/9423340301	Fx 01-341401		54
3463560801/3463563001/3463562001 3463562301	Fx 01-560801		55
3463561401/3463562401/3463562101 6253560101/346356001/3463560001	Fx 01-562101		56
3853560601/3853561401	Fx 01-560601		57

INDEX

SUITABLE TO OEM NOS	FOX NO.	ALT. BEARING NOS	PAGE NO.
3873340601	Fx 01-340601		58
4472435160/0003560401/9463560501	Fx 01-435160		58
9463560401/0003500535/9463560401			
3563340201/3563340001	Fx 01-340201		59
3563560001	Fx-560001		60
0003300725/9433340945	Fx 01-300725		60
9463560701/4003560701	Fx 01-560701		61
3463562901/3463562801/9423561701	Fx 01-562901		62
0003500535/9463560501/9463560401	Fx 01-500535		63
4472435370/4472433570/4474335074	Fx 41-435370		64
4472435370/4474435370			
9703340145/9703340045	Fx 01-340145		64
9433340701/9433301125	Fx 01-340701		65
9703340345/9723300525/9723300125	Fx 01-340345		66
9723300225/9703340344/9723300325			
9723300425/9723300625/9703300144			
9433300825	Fx 01-300825		67
9423560801/9423560001	Fx 01-560801		68
9423561301	Fx 01-561301		69
4474385118	Fx 41-385118		69
9423560901	Fx 01-560901		70

INDEX

SUITABLE TO OEM NOS	FOX NO.	ALT. BEARING NOS	PAGE NO.
9433301125/9433340701	Fx 01-301125		71
9423340301/9423341401	Fx 01-340301		72
9463300335/9703500335/9703560301	Fx 01-300335		72
9753300425/9753300825	Fx 01-300425		73
9433301225/943330125/0003300725	Fx 01-301225		74
9763561801/9763561101/9763560701 9754230112	Fx 01-561801		75
6153560301/3853560801/3853561301	Fx 01-560301		75
3463562401	Fx 01-562401		76
6233340101/6233340001/6233341401 3073340401	Fx 01-340101		77
6553340101/6553340001/3893341501	Fx 01-340101		78
6283340001/6283340301/3573340301	Fx 01-340001		78
4003340301/6243340301/6243340201 6263341001	Fx 01-340301		79
3893340601/6243340001/3893341401 6243340401/6243340501/6243340101	Fx 01-340601		80
3553340501/3853340601/3853341001 3853341101	Fx 01-340501		81
3853560101/3453560101/3853561001 3853561101	Fx 01-560101		82
3023560401	Fx 01-560401		82

OEM to FOX NOS



INDEX

SUITABLE TO OEM NOS	FOX NO.	ALT. BEARING NOS	PAGE NO.
3463562501	Fx 01-562501		83
3463563101	Fx 01-563101		84
9463560701	Fx 01-560701		85
0003501235/4472336309/ZF 4474335121 ZF 4473755725/4474335169	Fx 01-501235		86
0003502335/9463562601/0003500535 JAE0250302801	Fx 01-502335		86
6683560301/6683500035	Fx 01-560301		87
4472435370/4472433570	Fx 41-435370		87
0003500635/4472435376/9493340501 9493340801	Fx 01-500635		88
31511303	Fx 01-511303		88
3307205600/3307300700	Fx 40-205600		89
1307300310	Fx 40-300310		90
3307300600/3307300601/3307300300 1307104213/1307970822/1307300614 3307301200	Fx 40-300600		91
2307104200/2307104212/2307106000 2307106300/23010421200	Fx 40-104200		92
2307105400	Fx 40-105400		93
1307302510/3307302501	Fx 40-302510		93

INDEX

SUITABLE TO OEM NOS	FOX NO.	ALT. BEARING NOS	PAGE NO.
1307105510	Fx 40-105510		94
01146200100/01146200401/1146200402	Fx 40-200100		94
3307303000/3307303001/1307304310	Fx 40-303000		95
1307306610/3307305600/3307305601 330735603	Fx 40-306610		95
3307304301/3307304300/3307304302 13073043010	Fx 40-304301		96
330711660/1307116600	Fx 40-711660		97
1307106800/650275D/0018321C	Fx 41-106800		98
1307112901/1307112900/1307112711	Fx 40-112901		98
3307304600/3307304601	Fx 40-304600		99
3307116600/3307116601	Fx 40-116600		100
3307205600/3307300700	Fx 40-205600		101
3307304500/3307304501/3307304502	Fx 40-304500		101
0327227200	Fx 11-227200		102
0327227410/0980106500 S1	Fx 11-227410		102
0327227480/0980106540 S	Fx 11-227480		103
0327244210/0327244300/0327244170	Fx 11-244210		103
0327244240/0327227200/0327244210	Fx 11-244240		104
0327248320/9763561101/9463560201			
3463560301/6233340001/8335701052			
81443013146/81357013128/81357013152			

OEM to FOX NOS



INDEX

SUITABLE TO OEM NOS	FOX NO.	ALT. BEARING NOS	PAGE NO.
0327244340/0980106520 S	Fx 11-244340		105
0327244400/0980106560 S	Fx 11-244400		105
0327228560	Fx 11-228560		106
0327243140/0327243141/0327243142 0980106580/03272431602	Fx 11-243140		106
0327230990/0327230990 S	Fx 11-230990		107
0127243280/098107320/0327243280 0980107320 S	Fx 11-243280		107
0327246110	Fx 11-246110		108
0327230310/0327230190	Fx 11-230310		108
0327230340/0327230350/0327230620 0327230410	Fx 11-230340		109
0327230810	Fx 11-230810		110
0327230950/0327230970/0980106050 S	Fx 11-230950		110
0327230410/0327230620/0327230350	Fx 11-230410		111
0327230300/0327230070/0327230050 0327230380/8241000482	Fx 11-230300		112
0327230870/0327230810/0980106030	Fx 11-230870		112
0327248460/0327248400/0327248620 0327248450/0327248390	Fx 11-248460		113
0327248320/0BP327248070/0327248100 0327248120	Fx 11-248320		114

OEM to FOX NOS



INDEX

SUITABLE TO OEM NOS	FOX NO.	ALT. BEARING NOS	PAGE NO.
0327243100/0327243102 S	Fx 11-243100		115
0980106070 S			
0327232050/0327232050 S	Fx 11-232050		116
0327248780/0980106040/0980106720	Fx 11-248780		116
0327243120/0980106060/0327243232	Fx 11-243120		117
0980106082			
0327243200/0327248780/0980106040 S	Fx 11-243200		117
0980106720 S			
0327248330/0327248170/0327248350	Fx 11-248330		118
0327248520	Fx 11-248520		119
0327262270/0327262190/0327262200	Fx 11-262270		120
0327248970/0327243120/0327248950	Fx 11-248970		120
0980106060/0327243232/0980106082			
0327280860/0327280060/0327280070	Fx 11-280860		121
0327280180/0327280100/0327280190			
0327286100/0327280140			
0327262350	Fx 11-262350		122
0327247330/0980106130 S/0980106140 S	Fx 11-247330		122
0327243290	Fx 11-243290		123
0327243222	Fx 11-243222		124
0327246330	11-246330		124

INDEX

SUITABLE TO OEM NOS	FOX NO.	ALT. BEARING NOS	PAGE NO.
0327248970	Fx 11-248970		125
0327246280/0980106690 S/0327246282	Fx 11-246280		125
0327243262	Fx 11-243262		126
0327246302	Fx 11-246302		126
0327262350	Fx 11-262350		127
0327263060/0327263080/0327263120	Fx 11-263060		127
0327228350	Fx 11-228350		128
1868663/1480933/1724406/1391369 1866430	Fx 06-868663		129
1800283/1382884	Fx 06-800283		130
1724790	Fx 06-724790		131
379188/397186/562051	Fx 06-379188		132
1868674/1414154/1382774/1371596 1724407	Fx 06-868674		133
337565/255348/347945/255348/1724788	Fx 06-337565		134
337563	Fx 06-337563		135
1626994/20374418	Fx 16-626994		136
20535207/20819804/1075408/20820402 1075428/1076526/7420819806 7421328181	Fx 16-535207		137
21024160/21024166/20518092/20534905 74535202/7420534904/74210214160	Fx 16-024160		138

OEM to FOX NOS



INDEX

SUITABLE TO OEM NOS	FOX NO.	ALT. BEARING NOS	PAGE NO.
3988930/85114471/85111794/3989341	Fx 16-988930		139
8510818/85105693			
1026798/20252417/20535202/85107750	Fx 16-026798		140
85111448/8514470/85111791/21024206			
7420535202/7421024206/7421116569			
7485114470			
20516966/20535263/85107753	Fx 16-516966		141
85105696/3092720/85104298			
20517164/1078053/85104301	Fx 16-517164		142
85111792/85105692	Fx 16-111792		143
3943982/20476519/20518054/20517950	Fx 16-943982		144
20517952			
20518092/21024155	Fx 16-518092		145
1724407/1414154	Fx 08-724407		146
98CT1106/RFC1106AB	Fx 08-CT1106		147
20819804/1075408/20820402/1075428	Fx 16-819804		148
21328177/21328181/20535207			
7421328181/7420819806			
5010566112/5000682333	Fx 30-566112		149
7421021381/7410241087	Fx 30-021381		150
5010241087	Fx 30-241087		150
7420517167/1026661/5001861915	Fx 30-517167		151
7421022433/7485111789/85107749	Fx 30-022433		152
85111789			

OEM to FOX NOS



INDEX

SUITABLE TO OEM NOS	FOX NO.	ALT. BEARING NOS	PAGE NO.
AJB 0038001/CF-1014228/448057	Fx 42-038001		153
M006077/CF103079	Fx 42-006077		153
M007851/CF1031007	Fx 42-007851		154
6502795D/0018321C	Fx 42-02795D		154
CF1031007/M006050/449557 449629/M007851	Fx 42-031007		155
81443010169/81443013156/81443010174	Fx 22-010169		156
81357010155/81357013155	Fx 22-010155		157
81357010141/81357010086	Fx 22-010141		158
81443010182	Fx 22-010182		159
81357013147/81357010147	Fx 22-013147		159
81357006150/81357013174/81357006136	Fx 22-006150		160
81357010174			
81357010111/81357010159/81357010142	Fx 22-010111		161
81357010126/81357010140/81357013126	Fx 22-010126		161
83443010000/81443010107 9013022181369	Fx 22-010000		162
83357010004/81357010081 81357010128/81357010028	Fx 22-010004		162
81443010146/81443013146	Fx 22-010146		163

OEM to FOX NOS



INDEX

SUITABLE TO OEM NOS	FOX NO.	ALT. BEARING NOS	PAGE NO.
81357010142/81357010159/81357013111	Fx 22-010142		164
81357010111/8135701015/8135701041			
8144300182	Fx 22-300182		164
81443013159/81443010159	Fx 22-013159		165
81443010179/81443011759			
81357013152/81357010151ZF	Fx 22-013152		165
81357013128	Fx 22-013128		166
81357010161	Fx 22-010161		166
81357010176/81357016040	Fx 22-570101		167
4474335121/36357010000			
81443010195/81443010177	Fx 22-010195		168
81443010178	Fx 22-010178		168
81357010165	Fx 22-010165		169
81443010176/81443013176	Fx 22-010176		170
21203219/14203219	Fx 37-203219		171
21226120	Fx 37-226120		171
21204561/21204562/14204561/14204562	Fx 37-204561		172
21228120	Fx 37-228120		173
14225425	Fx 37-225425		173
14226120	Fx 37-226120		174

OEM to FOX NOS



INDEX

SUITABLE TO OEM NOS	FOX NO.	ALT. BEARING NOS	PAGE NO.
21210885 R/14210885	Fx 37-210885		175
14227483/21227483	Fx 37-227483		175
21225290/14225290	Fx 37-225290		176
14219784/212211625	Fx 37-219784		176
21219784/21220158			
7168364/4685285	Fx 36-168364		177
7168365/4686447	Fx 36-168365		177
7168588/7169999/7162807/7168587	Fx 36-168588		178
7179929/7168464/7181782/7178829	Fx 36-179929		178
7172551	Fx 36-172551		179
7173327/7182031/1782032/7173326	Fx 36-173327		179
42104691/42104692	Fx 36-104691		180
7180909/7179742/2996882	Fx 36-180909		181
7183906/7180797/7188706	Fx 36-183906		182
7168593	Fx 36- 168593		182
71733114/7173316/7173315	Fx 36-733114		183
7173696	Fx 36-173696		183
42101361/42037491/42101959/42101918	Fx 36-101361		184
42037492	Fx 36-037492		184

BEARING HUB UNIT

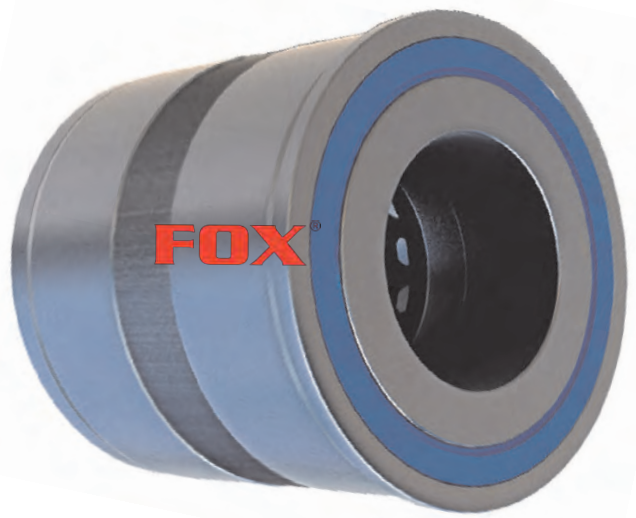

Fx BTH 0018A

201037 571762.H195

571762.01.H195

VKBA 5314

SET 1231/ NP 078914

NP273671 90U86



d(mm.)	D(mm.)	T(mm.)	Wt.
68/68,2	127/132	115	6.257 Kg

OEM REFERENCES

SCANIA 1413785 / 1439070 /
1443078 / 1476945 /2310169/
1724482 /1868087/1365570/
1476945/1413785/1336296/
1382900/1356897

POSITION

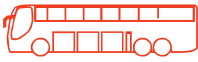
FRONT
AXLE

FOR VEHICLE			
SCANIA	SERIE 3	93	
		113	
		143	
		K3	
		K4	
		SERIE 3	
		SERIE 4	

BEARING HUB UNIT

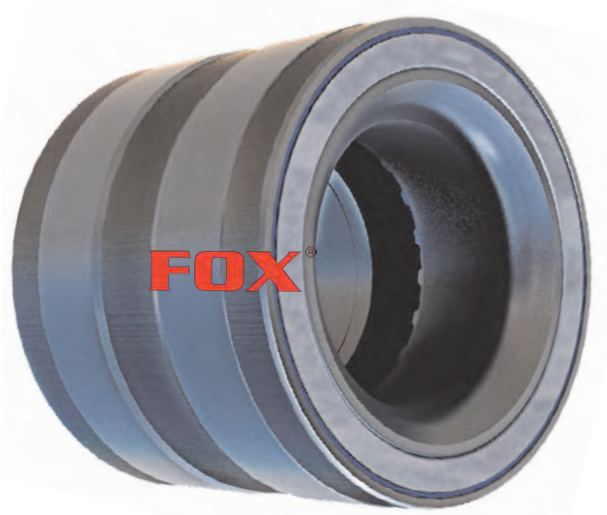

Fx BTH 0022

VKBA 5412
 BTH 0055
 VKBA 5552
 201034
 HDS 103
 805003A.H195
 SET 1310



d(mm.)	D(mm.)	T(mm.)	Wt.
82	140	115	6.450 Kg

OEM REFERENCES

MB 014 981 5105/ 014 981 9305 /
 014 981 9905/ 017 981 5005/ 016
 981 2805/ 021 981 7005
 GIGANT 9272681/9272778

POSITION

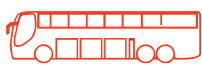
TRAILER
 REAR AXLE

FOR VEHICLE			
MERCEDES	Actros		D-SERIE D-SERIE
	Antos		TE TL
	Arocs		TZ
	Axor 2		SPR SCS SKO

BEARING HUB UNIT

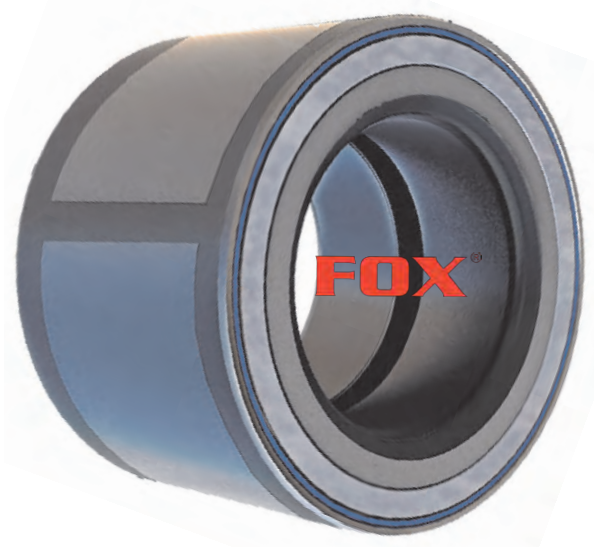

Fx 201050

DU60108-8

SET 1349

d(mm.)	D(mm.)	T(mm.)	Wt.
60	180	75	2.835 Kg



OEM REFERENCES

MB 015 981 1905/014 981 5705

POSITION

TRAILER

AXLE

FOR VEHICLE			
MERCEDES		ACTROS MP2 ATEGO 2 AXOR 2	

BEARING HUB UNIT



d(mm.)	D(mm.)	T(mm.)	Wt.
77	130	91	4.410 Kg

Fx 805092 C

805092.07

VKBA 5415

VKBA 5418

NP 79315490UA3

SET 1263

OEM REFERENCES

DANA - 833202

IVECO - 7182915/7181863

MAN - 81934200336/

81934200379/ 81934206083/



81934206099

VOLVO - 85103257

POSITION

REAR

AXLE

FOR VEHICLE			
IVECO	EUROPOLIS ELECTRICO	EUROCARGO	
MAN		TGL TGM L 2000	
VOLVO		FL6	

WHEEL HUB



Fx BTH 1011

VKBA 3552

713 6908 40



d(mm.)	D(mm.)	T(mm.)	Wt.
55	90	60	1.400 Kg

OEM REFERENCES

IVECO 7180066

POSITION

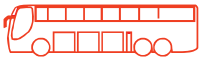
REAR
AXLE

FOR VEHICLE			
IVECO		DAILY	

BEARING HUB UNIT



d(mm.)	D(mm.)	T(mm.)	Wt.
90	160	125	10.250 Kg

Fx BTH 0053



NP318274-90UA7
 SET 1242
 NP 724254-90UA7
 201059
 805012.06.H1 95
 VKBA 5397
 BTH 0025

OEM REFERENCES

IVECO - 1905487 / 2996882/
 7179751 / 7183074/
 7183075 /7189050/
 7189648/7179749
DAF - 1408086/1400291

POSITION

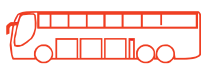
REAR
 AXLE

FOR VEHICLE			
IVECO		EUROSTAR	
		STRALIS	
IRISBUS	EURORIDER	FL6	
DAF		LF55	

BEARING HUB UNIT

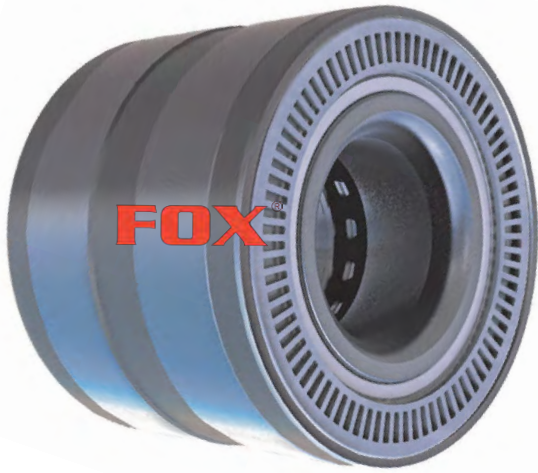

Fx 201072

NP 493386

VKBA 5413



d(mm.)	D(mm.)	T(mm.)	Wt.
90	160	125,5	

OEM REFERENCES

IVECO 42537774 / 42539148

POSITION

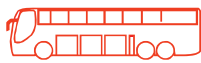
REAR
AXLE

FOR VEHICLE			
IVECO	ARWAY		
	EUROCLASS		
	EURORIDER		

BEARING HUB UNIT



Fx 566283.01.H195

SKF VKBA 5431

SET 1352



d(mm.)	D(mm.)	T(mm.)	Wt.(kg)
99,8/100	148/148	67,5/67,5	6

OEM REFERENCES

DAF 1801594

POSITION

REAR
AXLE

FOR VEHICLE			
DAF		45, 55	
		75 CF	
		85, 85 CF	
		95, 95 XF	
		CF 65, CF 75, CF 85	
		LF 45, LF 55	
		XF 95, 105	



Fx 803194 A

803194.26

VKBA 5415

BTH 0010D

NP 793154

d(mm.)	D(mm.)	T(mm.)	Wt(kg.)
78	130	90	4.4

OEM REFERENCES

MERCEDES - 013 981 2205 /
013 981 2305 / 013 981 9805

IVECO - 1703859/7182915

MAN - 81934200336/
81934200379/ 8193420683/
81934206099/ 8193420612

VDL - 30030522



VOLVO - 85103257

DANA - 833202

POSITION

REAR

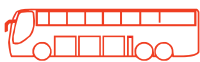
AXLE

FOR VEHICLE			
MERCEDES		ATEGO ATEGO-2 TOURINO	
IVECO		EUROCARGO I-IV	
MAN		TGL, TGM	
MB		ATEGO-3	
RENAULT		D-SERIES	
VOLVO	FL 6	FL 6	



Fx 805011 C
VKBA 5409
BTH 0054
SET1237
NP4058190UA1



d(mm.)	D(mm.)	T(mm.)	Wt(kg.)
82	140	110	6.60

OEM REFERENCES

MERRITOR 2994058
IVECO 7184079 / 7184080

POSITION

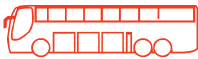
REAR
AXLE

FOR VEHICLE			
IVECO		EUROCARGO	
MERITOR			TC

BEARING HUB UNIT



d(mm.)	D(mm.)	T(mm.)	Wt(kg.)
78	130	90	4.4



Fx 201043
HDS 001
HUR 040
579205.H195
BTF 0045
VKBA 5420
VKBA 5316
SET1350

OEM REFERENCES

RENAULT - 50 10 439 770
IVECO - 504189654
VOLVO - 20764313

POSITION

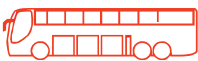
FRONT
AXLE

FOR VEHICLE			
RENAULT		KERAX MAGNUM PREMIUM	
IVECO		MAGELYS URBANWAY	
IRISBUS		ARES, ARWAY AXER, CITELIS	

BEARING HUB UNIT



Fx VKBA 3553

713690850

BTFB 328755D

VKBA 3553



d(mm.)	D(mm.)	T(mm.)	Wt(kg.)
45	120	85	4

OEM REFERENCES

IVECO - 93810034

POSITION

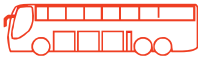
**FRONT
AXLE**

FOR VEHICLE			
IVECO		DAILY I	

BEARING HUB UNIT



Fx F-564734.H195

VKBA 5549

BTF 0056EB

d(mm.)	D(mm.)	T(mm.)	Wt(kg.)
82	196	110	14.8

OEM REFERENCES

SCHMITZ CARGOBULL -

1002689/ 100167600/

100167601/10167600

SAF - 1003457/3200200151/



3434365000 / 4200200100/

4200200101

POSITION

TRAILER

AXLE

FOR VEHICLE			
SCHMITZ CARGOBUL			SKI
			SPR
			SCS
			SKO
SAF			9019-1122

BEARING HUB UNIT



Fx 805532.01.H195



d(mm.)	D(mm.)	T(mm.)	Wt(kg.)
60	168	102	9.30

OEM REFERENCES

RENAULT - 20518611/20523890

POSITION

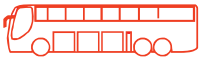
FRONT
AXLE

FOR VEHICLE			
RENAULT		MIDLUM	

BEARING HUB UNIT



Fx 201044
VKBA 5308



d(mm.)	D(mm.)	T(mm.)	Wt(kg.)
65	194	113	11.87

OEM REFERENCES

**RENAULT - 5010216920/
7420879770**

POSITION

**FRONT
AXLE**

FOR VEHICLE			
RENAULT		KERAX	
		MAGNUM	
		MAJOR	
		MAXTER	
		PREMIUMI	

BEARING HUB UNIT



Fx 801974AE.H195

BTF 0110
VKBA 5377
BTF 0021A
201012



d(mm.)	D(mm.)	T(mm.)	Wt(kg.)
70	196	140	13.20

OEM REFERENCES

IVECO-42541578/5006207845
MAN - 81934200288/
81934200330/ 81934200349

POSITION

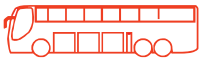
FRONT
AXLE

FOR VEHICLE			
MAN	HOCL	TGA	
	LION COACH	TGM	
	LION CITY	TGS	
	LION STAR	TGX	
	NG	E 2000	
	NL	F 2000	
	NM	M 2000	
	NÜ		
	RH		
	SG		
	SL		
	SÜ		
	TOURLINER		
IVECO	ÜL		
	UN		
	CITYCLASS		
	EUROPOLIS		



Fx 201042

HDS 002

HUR 056



d(mm.)	D(mm.)	T(mm.)	Wt(kg.)
50	140	95	5.40

OEM REFERENCES

RENAULT- 5010566154/7421190412
VOLVO- 21190412

POSITION

FRONT
AXLE

FOR VEHICLE			
RENAULT		MIDLUM	



Fx 201082

VKBA 5411

BTF 0074A



SET 1337

d(mm.)	D(mm.)	T(mm.)	Wt(kg.)
55	145	100	6.00

OEM REFERENCES

MAN 81934200337

POSITION

FOR VEHICLE			
MAN			

BEARING HUB UNIT





Fx 805531/165
VKBA 5407
BTF 0068

d(mm.)	D(mm.)	T(mm.)	Wt(kg.)
60	168	102	9.300

OEM REFERENCES

RENAULT - 5010587029
VOLVO - 20550678/85124433

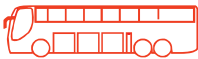
POSITION

FOR VEHICLE			
RENAULT			



Fx 566283.H195

505208 W

805008C

805052C



VKBA 5431

d(mm.)	D(mm.)	T(mm.)	Wt(kg.)
100	148	135	6

OEM REFERENCES

DAF - 1801594/1812161/
1818003

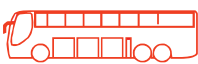
POSITION

FOR VEHICLE			
DAF	45, 55		
	75 CF		
	85, 85 CF		
	95, 95 XF		
	CF 65, CF 75, CF 85		
	LF 45, LF 55 XF 95, 105		



Fx 803904

503809

3434301200



d(mm.)	D(mm.)	T(mm.)	Wt(kg.)
120	175	123	

OEM REFERENCES

SAF-03434301200/4373004400/
 5387001105/4200101602/
 4373004300/5387001503
 SCANIA-1723477/DAF 881002

POSITION

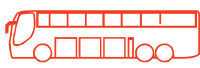
REAR
 AXLE

FOR VEHICLE			
SAF			

BEARING HUB UNIT



Fx F-566425.H195

VKBA 5423
SET 1314
800792D
HDS 219

d(mm.)	D(mm.)	T(mm.)	Wt(kg.)
93.8	148	135	6.050

OEM REFERENCES



RENAULT - 7420819860/
7420819846/5001861915/
7420535262/7420535264/
7420792439/7420819859/
7420819834

SCANIA - 2277946

VOLVO - 0792439/20964828/
21036050/20518661/
1075408 /20792440

POSITION

REAR
AXLE

FOR VEHICLE			
RENAULT			
VOLVO	B6		
	7700		
	8500		
	8700		
	9700		
	9900		
	FH12, FH16,		
	FL6, FL7,		
	FL10, FL12,		
	FM7, FM9,		
FM12,			
NH12			



Fx F-570530.H195

808918

SET 1370



d(mm.)	D(mm.)	T(mm.)	Wt(kg.)
88	138	120	5.058

OEM REFERENCES

SAF - 3434301900/03434302000/
03200102000

POSITION

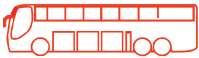
TRAILER
AXLE

FOR VEHICLE			
SAF			B, S, Z

BEARING HUB UNIT



Fx F-566193.H195



579065D

d(mm.)	D(mm.)	T(mm.)	Wt(kg.)
82	138	110	6.100

OEM REFERENCES

DAF - 1801593
SAF - 03434200101500/16105276

POSITION

FOR VEHICLE			
SAF			

BEARING HUB UNIT



Fx F-566834.H195

SET 1351

VKBA 5429



d(mm.)	D(mm.)	T(mm.)	BORE	Wt(kg.)
70	120/125	110.03	35/47.25 G1,22	4.15

OEM REFERENCES

DAF-1801595

POSITION

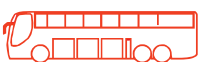
FRONT
AXLE

FOR VEHICLE			
DAF	45 / 55 / 75		
	CF 85, CF 95,		
	CF 65, CF 75,		
	CF 85		
	LF 45, LF 55		
	XF 95, 105		



Fx F-566074.H195

VKBA 5453

SET 1346



d(mm.)	D(mm.)	T(mm.)	Wt(kg.)
70	125	114	4.7

OEM REFERENCES

**DAF-1801592/16911621/
1699327/ 1818004**

POSITION

**FRONT
AXLE**

FOR VEHICLE			
DAF	75CF		
	85, 85CF		
	LF55		
	XF95		
	XF95II		
	XF 95, 105		
	XF105		

BEARING HUB UNIT

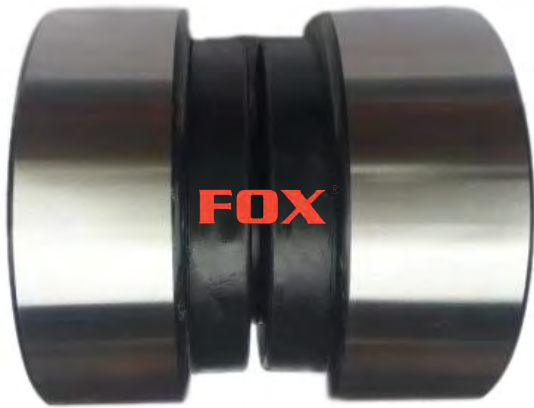

Fx F-566427.H195

805165
VKBA 5424
SET 1311

d(mm.)	D(mm.)	T(mm.)	Wt(kg.)
57.8	110	115	4.5



OEM REFERENCES

RENAULT - 7420518617/
742102181/ 7421022434/
7421024188

VOLVO-2051861/22008157/
20967830/20589393/
20589394/21021381

POSITION

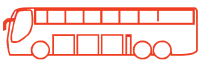
FRONT / REAR
AXLE

FOR VEHICLE			
RENAULT	MAGNUM DXI		
	PREMIUM 2		
	C SERIES,		
	T SERIES, K SERIES		
VOLVO	B6, B9,		
	7700, 8500,		
	8700, 9700,		
	9900		
	FM		
	NH 12		
FH			
FE			





Fx 201009
BT1B328251
VKHB 2240
201075

d(mm.)	D(mm.)	T(mm.)	Wt(kg.)
55	100	40	1.090

OEM REFERENCES

MAN - 06324990103 / 06324990104
06324890072/06324890073

POSITION

FOR VEHICLE			
MAN			



Fx 581079C
566426.H195
VKBA 5425
SET 2312

d(mm.)	D(mm.)	T(mm.)	Wt(kg.)
68/68,2	125	115	4.490



OEM REFERENCES

VOLVO - 3988674 / 3988675/
 20382168/ 20518092/ 20518093/
 20518637/ 20558950 /20581399/
 20728008/ 20967831/ 1075408/
 20792440

RENAULT - 7420535203/
 7421024206/7420518637/
 7420535202/7421021391/
 7421024208/7420967831

POSITION

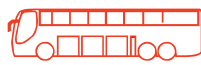
FRONT / REAR
 AXLE

FOR VEHICLE			
VOLVO	5000, 7000	FH 12, FH16	
	7500, 7700	FL 6, FM 10	
	8300, 8700	FM 12, FM 7	
	9700, 9900	FM 9, NH 12	
	B6R		
	B9S B9TL		
RENAULT	MAGNUM		
	C SERIES		
	T SERIES		
	K SERIES		
	PREMIUM 2 KERAX		



Fx 803750 B

VKBA 5408

BT20130A

HDS 220

SET 1335



d(mm.)	D(mm.)	T(mm.)	Wt(kg.)
105	160	140	6.890

OEM REFERENCES

MAN - 36934200009/
503126457/81934200376/
81934200320/81934200342
IVECO - 503126457

POSITION

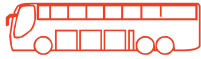
REAR
AXLE

FOR VEHICLE			
BOVA	FUTURA LEXIO MAGIG SINERGY		
MAN	LION COACH LION CITY HOCL NG NL NÜ SL ÜL	TGA TGM TGS TGX M 2000	
NEOPLAN	CITYLINER EUROLINER STARLINER		
VOLVO	7700 8500 8700		
MERCEDES	CITARO		



Fx 566830.H195



d(mm.)	D(mm.)	T(mm.)	Wt(kg.)
120	175	123	7.200

OEM REFERENCES

SAF - 04200101602/03434301000
03434301200

POSITION

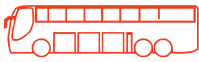
TRAILER
AXLE

FOR VEHICLE			
SAF			

BEARING HUB UNIT



Fx 569868.H195



d(mm.)	D(mm.)	T(mm.)	Wt(kg.)
82	138	110	5,85

OEM REFERENCES

SAF-3434301800/04200101900

POSITION

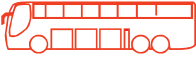
TRAILER
AXLE

FOR VEHICLE			
SAF			SKRB SKRLB

WHEEL KIT



Fx 804162 A

VKBA 5416



d(mm.)	D(mm.)	T(mm.)	Wt(kg.)
110	170	146	8.530

OEM REFERENCES

MAN - 81934200346/81934206098

POSITION

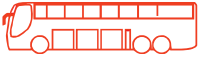
REAR
AXLE

FOR VEHICLE			
MAN		TGA	
		TGM	
		TGS	

HUB REP. KIT



Fx VKBA 2451

OEM REFERENCES

BPW

0980107340/0264102300S

33213-K / 33118-K

POSITION



Fx VKBA 2451

VKBA 5551

OEM REFERENCES

BPW 0980106270

33118K/33213K

POSITION



Fx VKBA 5521

<u>d(mm.)</u>	<u>D(mm.)</u>	<u>B(mm.)</u>	<u>Wt(kg.)</u>
50/80	110/130	42,25/37	5,11

OEM REFERENCES

BPW - 0980102720/0980102330

ROR - 0264065000/723700110

32310 / 33116

POSITION



Fx VKBA 2421

OEM REFERENCES

BPW - 0980102720

33116/ 32310

POSITION



d(mm.)	D(mm.)	B(mm.)	Wt(kg.)
90/65	150/120	45/41	6,64

Fx VKBA 5522
VKBA 2422

OEM REFERENCES

BPW - 0980102340
ROR - 0264076500/723700510
33118/33213

POSITION



d(mm.)	D(mm.)	B(mm.)	Wt(kg.)
65/89,975	150/120	45/41	6,64

Fx VKHB 2029

VKHB 2051
VKHB 5507
VKHB 2405S

OEM REFERENCES

VOLVO - 184672
MAN - 06324890046
BPW - 0264076500/264102200
FAG-723700810
33213/HM218248/HM218210

POSITION



Fx VKBA 5527

OEM REFERENCES

BPW - 0980102340
33213/33118

POSITION



Fx VKBA 5524

OEM REFERENCES

BPW 0980102980
33118/33213

POSITION



Fx VKBA 2425

723 7001 10

VKBA 5525

OEM REFERENCES

BPW 0980102190

POSITION



Fx VKBA 5526

OEM REFERENCES

BPW 0980102200

33213,33118

POSITION



Fx VKBA 5560
VKBA 2450

OEM REFERENCES

BPW-0980106260

POSITION



Fx 11-102170

OEM REFERENCES

BPW-0980102170
32310/33116

POSITION



Fx 11-102180

OEM REFERENCES

BPW-0980102180

33218/33213

POSITION



Fx 01-503835

OEM REFERENCES

MERCEDES-942 350 3835

POSITION



Fx 01-502735

OEM REFERENCES

MERCEDES-000 350 2735

POSITION



Fx 01-01835

OEM REFERENCES

MERCEDES-940 350 1835

POSITION



Fx 40-00600S

OEM REFERENCES

SAF-4200100600 S

POSITION

SUITABLE BEARING

33213/HM 218248/HM 218210



Fx 40-362300

OEM REFERENCES

SAF - 3434362300

POSITION

SUITABLE BEARING

32924



Fx 40-301600

OEM REFERENCES

SAF - 3434301600

POSITION

SUITABLE BEARING

33213/HM 218248/HM 218210



Fx 06-70075S

OEM REFERENCES

SCANIA - 370075 S

POSITION



Fx 06-04500S

OEM REFERENCES

SCANIA - 1104500 S

POSITION

REP.KIT, WHEEL HUB



Fx 06-735498

OEM REFERENCES

SCANIA - 1735498

POSITION

SUITABLE BEARING

HM 218248/HM 218210



Fx 06-40992S

OEM REFERENCES

SCANIA - 1740992 S

POSITION



Fx 06-550905

OEM REFERENCES

SCANIA - 550905

POSITION



Fx 11-106260

OEM REFERENCES

BPW - 0980106260

POSITION

SUITABLE BEARING

33118/ 33213



Fx 11-02400S

OEM REFERENCES

BPW- 0264102400 S

POSITION

SUITABLE BEARING

32310/33116



Fx 11-02300S

OEM REFERENCES

BPW - 0264102300 S

POSITION

SUITABLE BEARING

33118/33213



Fx 11-102200

OEM REFERENCES

BPW- 0980102200

POSITION

SUITABLE BEARING

33118/33213



Fx 11-102980

OEM REFERENCES

BPW - 0980102980

POSITION

SUITABLE BEARING

33213/33118

MERCEDES

LIFT AXLE WHEEL HUB



BARE



Fx 01-561101

DIMENSION

A-130mm C-20mm E-320mm Wt.-21.420kg
B-150mm D-290mm HOLES-8

MODEL

ATEGO 15/17

OEM REFERENCES

MERCEDES-9773561101/
9763560701

POSITION

WITH BEARING



SUITABLE BEARING

33020/33116

MERCEDES

WHEEL HUB

FOX[®]

B E A R I N G S

BARE



DIMENSION

A-130mm C-22mm E-382mm Wt.-23.300kg
B-150mm D-176mm HOLES-10

OEM REFERENCES

MERCEDES - 9423341201/
9423340701/9423340201/
9423341501/9423340201/
9493340801

WITH BEARING



Wt-31.520kg

SUITABLE BEARING

VKHB 2280/ 32312

Fx-01-341201

MODEL

18 / 40-18 / 48-32 / 40 AXOR
ACTROS OLD MODEL FRONT
(BEFORE 2008)

POSITION

MERCEDES

WHEEL HUB

FOX[®]

BEARINGS

BARE



DIMENSION

A-157mm C-22mm E-377mm Wt.-34.960kg
B-170mm D-297.50mm HOLES-10

Fx-560201

MODEL

ATEGO
15/1718/40-18/48-25/28-32 /
28-32/40-25/23 AXOR

OEM REFERENCES

MERCEDES-9463560201

POSITION

WITH BEARING



Wt. 43.470kg

SUITABLE BEARING

33022/ 567549

MERCEDES

WHEEL HUB

FOX[®]

BEARINGS

BARE



DIMENSION

A-130mm C-22mm E-380mm Wt.-23.100kg
B-150mm D-187mm HOLES-10

OEM REFERENCES

MERCEDES-3560101101/946
3560101/ 9463561301

WITH BEARING

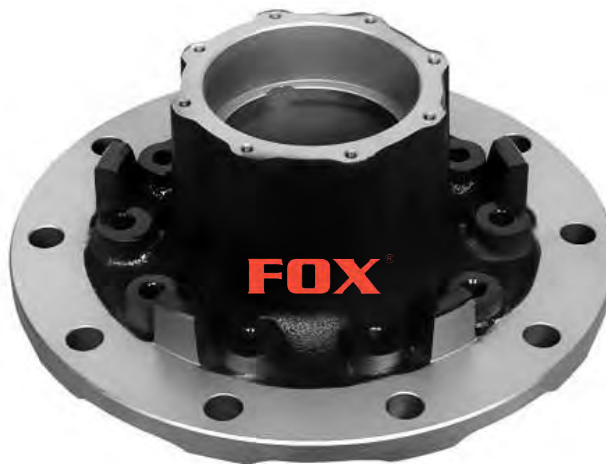

Wt. 27.315kg

SUITABLE BEARING

33020/33116

Fx-1010101

MODEL

25/28-32/28-32/40
AXOR

POSITION

MERCEDES

LIFT AXLE WHEEL HUB

FOX[®]

BEARINGS

BARE



DIMENSION

A-145mm C-22mm E-375mm Wt.-
B-150mm D-210mm HOLES-

OEM REFERENCES

MERCEDES-3553563601/
6173560501/3553563901/
3553563501/3463560401

Fx 01-563601

MODEL

25/21-25/24

POSITION

WITH BEARING



MERCEDES

WHEEL HUB

FOX[®]

BEARINGS

BARE

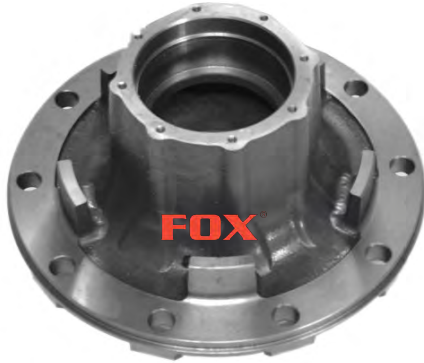

DIMENSION

A-130mm C-20mm E-320mm Wt.-
B-150mm D-290mm HOLES-

OEM REFERENCES

MERCEDES-3713567001/3713560001

Fx 01-567001

MODEL

26/22-25/24-25/21-25/17

POSITION

BARE



DIMENSION

A-120mm C-22mm E-380mm Wt.-31.220kg
B-150mm D-203mm HOLES-10

OEM REFERENCES

MERCEDES-9423341401/9423340301

Fx 01-341401

MODEL

KOGEL E.M.

SUITABLE BEARING

32311 / 33217

MERCEDES

WHEEL HUB

FOX[®]

BEARINGS

BARE

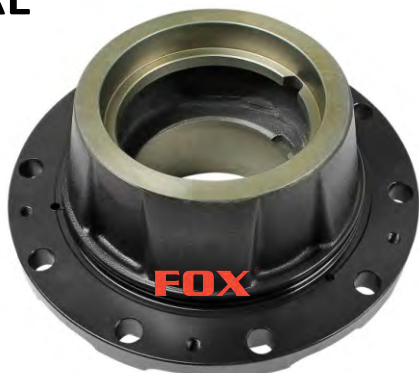

DIMENSION

A-180mm C-22mm E-369mm Wt.-33.820kg
B-170mm D-200,5mm HOLES-10

OEM REFERENCES

MERCEDES-3463560801/ 3463563001/
3463562001/ 346 3562301

WITH BEARING



Wt. 33.820kg

SUITABLE BEARING

33022 / 30220

Fx 01-560801

MODEL

30/31-30/27-26/35-26/31-26/
28-26/22-19/38

POSITION

REAR

MERCEDES

LIFT AXLE WHEEL HUB

FOX[®]

B E A R I N G S

BARE



DIMENSION

A-180mm C-22mm E-375mm Wt.-33kg
B-170mm D-219mm HOLES-10

OEM REFERENCES

MERCEDES-3463561401/
3463562401 /3463562101/
6253560101/346356001/
346356 0001

WITH BEARING



Wt. 46kg

SUITABLE BEARING

33022 / 30220

Fx 01-562101

MODEL

40/28-40/37

POSITION

MERCEDES

LIFT AXLE WHEEL HUB



BARE



Fx 01-560601

DIMENSION

A-140mm C-22mm E-377mm Wt.-31.360kg
B-150mm D-235mm HOLES-10

MODEL

V / 8 - 304-302 T - 303
UNDERGROUND

OEM REFERENCES

MERCEDES - 3853560601/
3853561401

POSITION

WITH BEARING



FOR ABS RING 160 mm

SUITABLE BEARING

33117 / 33020

MERCEDES

WHEEL HUB

FOX[®]

BEARINGS

BARE



DIMENSION

A-110mm C-22mm E-376mm Wt.-
B-130mm D-176mm HOLES-10

OEM REFERENCES

MERCEDES - 3873340601

Fx 01-340601

MODEL

CONNECTO V-8

POSITION

BARE



DIMENSION

A-160mm C-22,35mm E-377mm Wt.-
B-165mm D-243mm HOLES-

OEM REFERENCES

**MERCEDES - 4472435160/
0003560401/9463560501/
9463560401/ 0003500535/
9463560401**

Fx 01-435160

MODEL

CONNECTO 345 T
EURO 3-NEOPLAN

SUITABLE BEARING

BTH 0022

MERCEDES

WHEEL HUB

FOX[®]

BEARINGS

BARE



Fx 01-340201

DIMENSION

A-110mm C-22mm E-380mm Wt.-30.240kg
B-150mm D-176mm HOLES-10

MODEL

0403-0404

OEM REFERENCES

MERCEDES - 3563340201/
3563340001

POSITION

FRONT

WITH BEARING



(FOR BRAKE DISC)

BARE



DIMENSION

A-140mm C-22mm E-380mm Wt.-
B-150mm D-276mm HOLES-

OEM REFERENCES

MERCEDES-3563560001

Fx-560001

MODEL

0403-0404

POSITION

FLANGE



DIMENSION

A- C-22mm E-382mm Wt.-17.640kg
B- D-26mm HOLES-

OEM REFERENCES

MERCEDES-0003300725/
9433340945

Fx 01-300725

MODEL

AXOR2008

POSITION

BARE



DIMENSION

A-160mm C-22mm E-377mm Wt.-37.140kg
B-170mm D-313mm HOLES-10

OEM REFERENCES

MERCEDES-9463560701/
4003560701

WITH BEARING



Wt. 45.580 KG

SUITABLE BEARING

567549 / 33022

Fx 01-560701

MODEL

18/48 ACTROS

POSITION

MERCEDES

WHEEL HUB

FOX[®]

BEARINGS

BARE



DIMENSION

A-157mm C-22mm E-375mm Wt.-34.200kg
B-170mm D-220mm HOLES-10

Fx 01-562901

MODEL

32 / 28-30 / 28-32 / 40-HL7
PULLING

OEM REFERENCES

MERCEDES-3463562901/346
3562801/ 9423561701

POSITION

WITH BEARING



Wt.40kg

SUITABLE BEARING

567549 / 33022

MERCEDES

WHEEL HUB



BARE



DIMENSION

A-140mm C-22mm E-380mm Wt.-23.360kg
B-140mm D-212.5mm HOLES-10

OEM REFERENCES

MERCEDES-0003500535/946
3560501/ 9463560401
JOST- JAE 0250302801 S

Fx 01-500535

MODEL

KOGEL Y.M.

POSITION

WITH BEARING



Wt. 30.040kg

SUITABLE BEARING

805003A.H195

MERCEDES

WHEEL HUB

FOX[®]

BEARINGS

BARE



Fx 41-435370

DIMENSION

MODEL

A-	C-	E-	Wt.-
B-	D-	HOLES-	

POSITION

OEM REFERENCES

NEOPLAN OTOBUS - 4472435370/
4472433570/4474335074/
4472435370/4474435370

FLANGE



Fx 01-340145

DIMENSION

MODEL

A-	C-18mm	E-290mm	Wt.-
B-	D-49.5mm	HOLES-	

OEM REFERENCES

MERCEDES - 9703340145/ 9703340045

POSITION

BARE



DIMENSION

A-140mm	C-20mm	E-199	Wt.-9.48kg
B-140mm	D-142.5mm	HOLES-10	

OEM REFERENCES

MERCEDES - 9433340701/9433301125

WITH BEARING



Wt.16.320kg

SUITABLE BEARING

805003A.H195

Fx 01-340701

MODEL

AXOR2008

POSITION

MERCEDES

WHEEL HUB

FOX[®]

B E A R I N G S

BARE



DIMENSION

A-108mm	C-14mm	E-146mm	Wt.-5.20kg
B-	D-113mm	HOLES-10	

OEM REFERENCES

MERCEDES - 9703340345/9723300525/
9723300125/9723300225/9703340344/
9723300325/ 9723300425/9723300625/
9703300144

Fx 01-340345

MODEL

Atego 1/2 730.713/714/719

POSITION



Wt. 8.053kg

MERCEDES

WHEEL HUB

FOX[®]

BEARINGS

BARE



DIMENSION

A-140mm C-20mm E-199mm Wt.-9.900kg
B- D-157.5mm HOLES-10

OEM REFERENCES

MERCEDES 9433300825

WITH BEARING



Wt.17.385kg

SUITABLE BEARING

805003A.H195

Fx 01-300825

MODEL

41/40 AXOR

POSITION

MERCEDES

WHEEL HUB

FOX[®]

BEARINGS

BARE

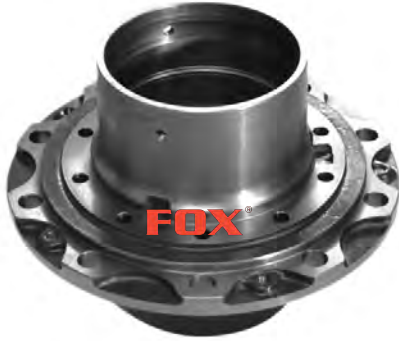

Fx 01-560801

DIMENSION

A-150mm	C-22mm	E-374.5	Wt.-31.280kg
B-160mm	D-263.5mm	HOLES-10	

MODEL

32 / 40-4140
CONSTRUCTION TYPE

OEM REFERENCES

MERCEDES-9423560801/9423560001

POSITION

WITH BEARING



SUITABLE BEARING

567549 / 33022

MERCEDES

WHEEL HUB



BARE

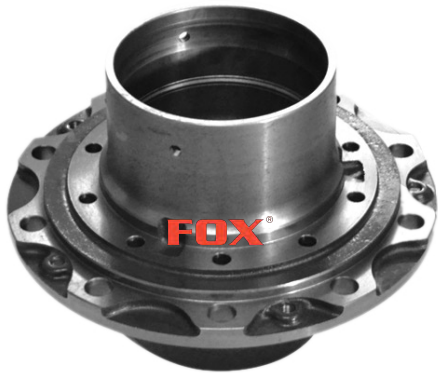

Fx 01-561301

DIMENSION

A-	C-	E-	Wt.-
B-	D-	HOLES-	

MODEL

NEW MODEL AXOR PULL

OEM REFERENCES

MERCEDES-9423561301

POSITION

BARE



Fx 41-385118

DIMENSION

A-100mm	C-22.6mm	E-384.5mm	Wt.-
B-130mm	D-186.5mm	HOLES-	

MODEL

OEM REFERENCES

NEOPLAN OTOBUS- ZF 4474385118

POSITION

FRONT

MERCEDES

WHEEL HUB



BARE

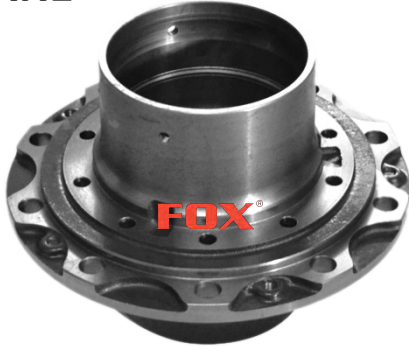

Fx 01-560901

DIMENSION

A-	C-	E-	Wt.-30.460kg
B-	D-	HOLES-	

MODEL

NEW MODEL AXOR PULL

OEM REFERENCES

MERCEDES-9423560901

POSITION

WITH BEARING



Wt. 37.740kg

SUITABLE BEARING

33022 / 567549

MERCEDES

WHEEL HUB



BARE



Fx 01-301125

DIMENSION

A-140mm C-20mm E-199mm Wt.-9.450kg
B- D-142.5mm HOLES-10

MODEL

TRAVEGO NEW MODEL
FRONT PAN

OEM REFERENCES

MERCEDES-9433301125/
9433340701

POSITION

WITH BEARING



Wt.16.320kg

SUITABLE BEARING

805003.H195

BARE



DIMENSION

A-120mm C-22mm E-380mm Wt.-31,220kg
B-150mm D-203mm HOLES-10

OEM REFERENCES

MERCEDES-9423340301/
9423341401

Fx 01-340301

MODEL

SUITABLE BEARING

32311/33217

BARE



DIMENSION

A-130mm C-18mm E-286mm Wt.-10.7300kg
B-130mm D-102mm HOLES-6

OEM REFERENCES

MERCEDES-9463300335/
9703500335/9703560301

Fx 01-300335

MODEL

SUITABLE BEARING

803194A

BARE



DIMENSION

A-130mm C-14mm E-168mm Wt.-7.40kg
B-130mm D-148mm HOLES-14

OEM REFERENCES

MERCEDES - 9753300425/
9753300825

WITH BEARING



Wt.12.90kg

Fx 01-300425

MODEL

POSITION

SUITABLE BEARING

803194A

MERCEDES

WHEEL HUB

FOX[®]

BEARINGS

BARE



DIMENSION

A-140mm C-20mm E-199mm Wt.- 9,448 kg
B- D-142.50mm HOLES-10

Fx 01-301225

MODEL

OEM REFERENCES

MERCEDES-9433301225/
943330125/ 0003300725

POSITION

WITH BEARING



Wt.16,320 kg

SUITABLE BEARING

805003A.H.195

MERCEDES

WHEEL HUB



BARE



DIMENSION

A-130mm C-20mm E-320mm Wt.-21.420kg
B-150mm D-290mm HOLES-8

OEM REFERENCES

MERCEDES 9763561801/9763561101/
9763560701/9754230112

Fx 01-561801

MODEL

SUITABLE BEARING

33116/33020

BARE



DIMENSION

A-140mm C-22mm E-377mm Wt.-
B-170mm D-235mm HOLES-

OEM REFERENCES

MERCEDES-6153560301/3853560801/
3853561301

Fx 01-560301

MODEL

25/17

POSITION

MERCEDES

WHEEL HUB



BARE



Fx 01-562401

DIMENSION

A-180mm C-22mm E-375mm Wt.-33kg
B-170mm D-219mm HOLES-10

MODEL

OEM REFERENCES

MERCEDES-3463562401

POSITION

WITH BEARING



Wt.46kg

SUITABLE BEARING

33022/30220

MERCEDES

WHEEL HUB

FOX[®]

BEARINGS

BARE



Fx 01-340101

DIMENSION

A-110mm C-22mm E-376mm Wt.-24.50kg
B-130mm D-176mm HOLES-10

MODEL

OEM REFERENCES

MERCEDES-6233340101/6233340001
6233341401/3073340401

POSITION

WITH BEARING



Wt.35kg

SUITABLE BEARING

534565/32310

BARE



DIMENSION

A-110mm C-22mm E-377mm Wt.-
B-130mm D-176mm HOLES-

OEM REFERENCES

MERCEDES-6553340101/
6553340001/ 3893341501

Fx 01-340101

MODEL

25/21/25/24/18/44

POSITION

BARE



DIMENSION

A-110mm C-22mm E-380mm Wt.-
B-130mm D-199mm HOLES-

OEM REFERENCES

MERCEDES-6283340001/628
3340301/ 3573340301

Fx 01-340001

MODEL

CONNECTO 2008

POSITION

FRONT

MERCEDES

WHEEL HUB



BARE



DIMENSION

A-110mm C-22mm E-378mm Wt.-24.760kg
B-150mm D-176mm HOLES-

Fx 01-340301

MODEL

30/31/40/38

OEM REFERENCES

MERCEDES-4003340301/6243340301
6243340201/6263341001

POSITION

WITH BEARING



Wt.30.580kg

SUITABLE BEARING

32314/32310

MERCEDES

WHEEL HUB

FOX[®]

BEARINGS

BARE



Fx 01-340601

DIMENSION

A-110mm C-22mm E-376mm Wt.-
B-150mm D-176mm HOLES-

MODEL

40/28/30/27/26/35/26/31/
26/28/26/22/19/38

OEM REFERENCES

MERCEDES-3893340601/6243340001/
3893341401/6243340401/
6243340501/6243340101

POSITION

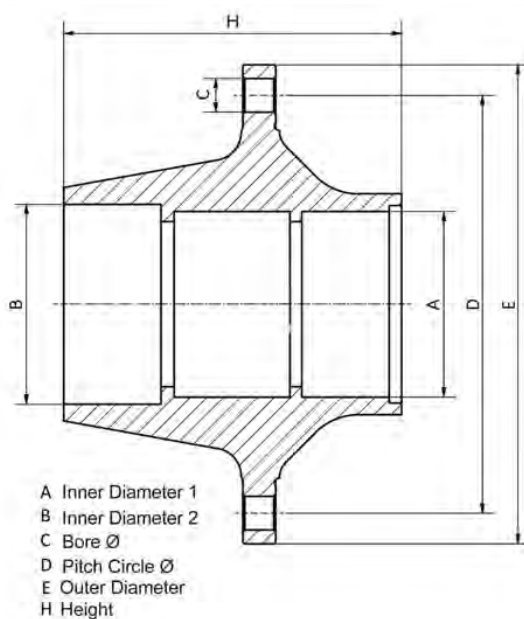

MERCEDES

WHEEL HUB

FOX[®]

BEARINGS

BARE



DIMENSION

A-90mm C-22mm E-369mm Wt.-
B-125mm D-177mm HOLES-

Fx 01-340501

MODEL

V/6 303 3025 TURBO / 302T

OEM REFERENCES

MERCEDES-3553340501/3853340601/
3853341001/3853341101

POSITION

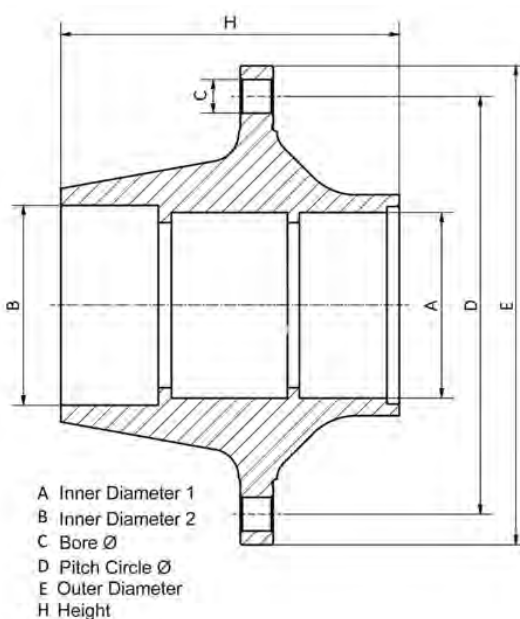

MERCEDES

WHEEL HUB

FOX[®]

BEARINGS

BARE



DIMENSION

A-130mm C-22mm E-378mm Wt.-
B-145mm D-200mm HOLES-

OEM REFERENCES

MERCEDES-3853560101/3453560101
3853561001/3853561101

Fx 01-560101

MODEL

V/6 303 YABANCI/302 SUPER

POSITION

BARE



DIMENSION

A-130mm C-22mm E-369mm Wt.-
B-152.40mm D-185mm HOLES-

OEM REFERENCES

MERCEDES-3023560401

Fx 01-560401

MODEL

302

POSITION

MERCEDES

WHEEL HUB

FOX[®]

BEARINGS

BARE



DIMENSION

A-145mm	C-22mm	E-375mm	Wt.-
B-160mm	D-210mm	HOLES-10	

OEM REFERENCES

MERCEDES-3463562501

WITH BEARING



SUITABLE BEARING

33021/32019X

Fx 01-562501

MODEL

CONNECTO 345 T

POSITION

MERCEDES

WHEEL HUB

FOX[®]

BEARINGS

BARE



DIMENSION

A-170mm C-22mm E-375mm Wt.-32 Kg
B-180mm D-213mm HOLES-10

OEM REFERENCES

MERCEDES-3463563101

WITH BEARING



SUITABLE BEARING

33220/33022

Fx 01-563101

MODEL

18/48 ACTROS

POSITION

REAR

MERCEDES

WHEEL HUB

FOX[®]

BEARINGS

BARE



DIMENSION

A-160mm C-22mm E-377mm Wt.-37 Kg
B-170mm D-313mm HOLES-

Fx 01-560701

MODEL

18/48 ACTROS

OEM REFERENCES

MERCEDES-9463560701

POSITION

WITH BEARING



Wt.45.500 Kg

SUITABLE BEARING

567549/33022

MERCEDES

WHEEL HUB



BARE

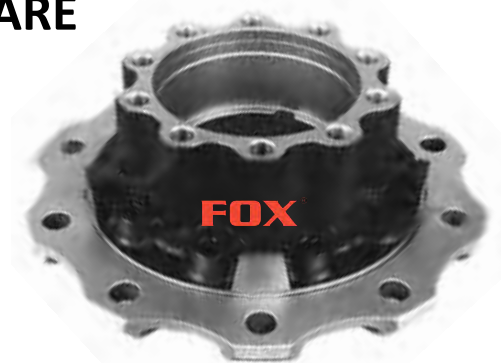

DIMENSION

A-160mm C-22mm E-380mm Wt.-26.8kg
B-160mm D-165mm HOLES-

OEM REFERENCES

MERCEDES-0003501235
NEOPLAN OTOBUS 4472336309/
ZF4474335121ZF4473755725/
4474335169

Fx 01-501235

MODEL

POSITION

BARE



DIMENSION

A-140mm C-22mm E-380mm Wt.-
B-140mm D-169.5 HOLES-

OEM REFERENCES

MERCEDES-0003502335/9463562601
0003500535/
JOST-JAE0250302801

Fx 01-502335

MODEL

KOGEL YM.

POSITION

MERCEDES

WHEEL HUB

FOX[®]

BEARINGS

BARE



DIMENSION

A-130mm C-18mm E-250mm Wt.-
B-130mm D-140mm HOLES-

OEM REFERENCES

MERCEDES-6683560301/6683500035

Fx 01-560301

MODEL

SPRINTER

SUITABLE BEARING

803194A

BARE



DIMENSION

A-160mm C-22.35mm E-380mm Wt.-
B-165mm D-252mm HOLES-

OEM REFERENCES

NEOPLAN OTOBUS- 4472435370/
4472433570

Fx 41-435370

MODEL

POSITION

MERCEDES

WHEEL HUB



BARE



DIMENSION

A-160mm C-22.4mm E-380mm Wt.-
B-165mm D-252mm HOLES-10

OEM REFERENCES

MERCEDES - 0003500635/
4472435376/ 9493340501/
9493340801

Fx 01-500635

MODEL

ACTROS,AXOR2,ACTROS MP2

POSITION

BARE



DIMENSION

A-100mm C-22mm E-392mm Wt.-
B-130mm D-183mm HOLES-

OEM REFERENCES

MERCEDES-31511303

Fx 01-511303

MODEL

POSITION

BARE



DIMENSION

A-120mm C-22mm E-270mm Wt.-15.850kg
B-147mm D-184mm HOLES-10

Fx 40-205600

MODEL

OEM REFERENCES

SAF-3307205600/3307300700

POSITION

WITH BEARING



Wt.21kg

SUITABLE BEARING

KHM 218248/HM218210,33213

SAF

WHEEL HUB



BARE



Fx 40-300310

DIMENSION

A-165mm C-22mm E-385mm Wt.-
B-165mm D-125mm HOLES-

MODEL

OEM REFERENCES

SAF-1307300310

POSITION

WITH BEARING



SUITABLE BEARING

800308/579056D

BARE



DIMENSION

A-175mm C-22mm E-385mm Wt.-25.100kg
B-175mm D-125mm HOLES-10

Fx 40-300600

MODEL

OEM REFERENCES

SAF-3307300600/3307300601/
3307300300/1307104213/
1307300611/1307970822/
1307300614/ 3307301200

POSITION

REAR

WITH BEARING



SUITABLE BEARING

566830.H195

BARE



Fx 40-104200

DIMENSION

A-120mm C-22mm E-384mm Wt.-21.500kg
B-147mm D-81,5mm HOLES-10

MODEL

OEM REFERENCES

SAF - 2307104200/
2307104212/2307106000/
2307106300/23010421200

POSITION

WITH BEARING



12 Tones

SUITABLE BEARING

KHM218248/HM218210/33213

BARE



DIMENSION

A-150mm C-22mm E-385mm Wt.-41.260kg
B-190mm D-288mm HOLES-10

OEM REFERENCES

SAF-2307105400

Fx 40-105400

MODEL

SUITABLE BEARING

32314/32221

BARE



DIMENSION

A-175mm C-22mm E-320mm Wt.-
B-175mm D-124mm HOLES-

OEM REFERENCES

1307302510/3307302501

Fx 40-302510

MODEL

YM.

POSITION

BARE



DIMENSION

A-130mm C-22mm E-380mm Wt.-
B-170mm D-223mm HOLES-

OEM REFERENCES

SAF-1307105510

Fx 40-105510

MODEL

YM.

POSITION

FLANG WHEEL HUB



DIMENSION

A- C-22/18mm E-386mm Wt.15KG-
B- D-69mm HOLES-10

OEM REFERENCES

SAF-01146200100/01146200401/
1146200402

Fx 40-200100

MODEL

SKRB 9019/9022 TIP

POSITION

SAF

WHEEL HUB

FOX[®]

BEARINGS

BARE



DIMENSION

A-138mm C-22mm E-385,5mm Wt.-
B-138mm D-144mm HOLES-

OEM REFERENCES

SAF-3307303000/3307303001/
1307304310

Fx 40-303000

MODEL

OLD MODEL

SUITABLE BEARING

805415

BARE



DIMENSION

A-138mm C-22mm E-380mm Wt.-
B-138mm D-170mm HOLES-

OEM REFERENCES

SAF-1307306610/3307305600
/ 3307305601/330735603

Fx 40-306610

MODEL

DISK PILOT

SUITABLE BEARING

570530.H195/808918/SET 1370

BARE



DIMENSION

A-138mm C-22mm E-380mm Wt.-17KG
B-138mm D-147mm HOLES-10

Fx 40-304301

MODEL

Y.MODEL KAMPANALI PİLOT

OEM REFERENCES

SAF-3307304301/3307304300/
3307304302/13073043010

POSITION

WITH BEARING

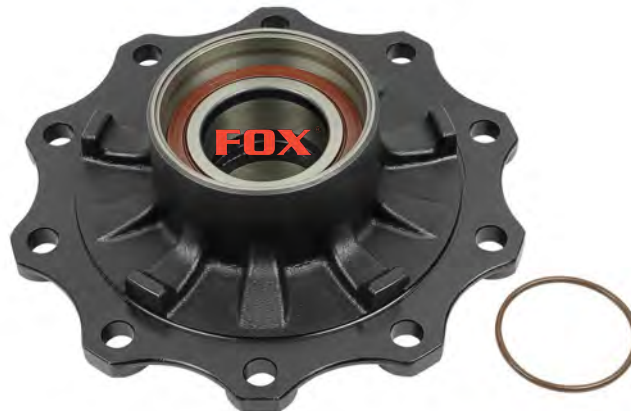

Wt.28KG

SUITABLE BEARING

570530.H195/ 808918

SAF

WHEEL HUB



BARE



DIMENSION

A-120mm C-22mm E-380mm Wt.-
B-147mm D-145.5mm HOLES-10

OEM REFERENCES

SAF-330711660/1307116600

WITH BEARING



Fx 40-711660

MODEL

SKRS SERIES PILOT

POSITION

SAF

WHEEL HUB

FOX[®]

BEARINGS

BARE



DIMENSION

A-130mm C-25.4mm E-371.5mm Wt.-23 Kg
B-145mm D-172mm HOLES-10

OEM REFERENCES

SAF-1307106800
FRUEHAUF 650275D/0018321C

Fx 41-106800

POSITION

REAR/FRONT

SUITABLE BEARING

570530.H195

BARE



DIMENSION

A-165mm C-22mm E-380mm Wt.-5 Kg
B-165mm D-134mm HOLES-10

OEM REFERENCES

SAF 1307112901/1307112900/
1307112711

Fx 40-112901

MODEL

SUITABLE BEARING

32924

SAF

WHEEL HUB

FOX[®]

BEARINGS



Fx 40-304600

DIMENSION

A-138mm C-22mm E-270mm Wt.-12.20kg
B-138mm D-148mm HOLES-10

MODEL

OEM REFERENCES

SAF 3307304600/3307304601

POSITION

WITH BEARING



Wt.16.800kg

SUITABLE BEARING

570530.H195/808918/SET 1370

BARE



DIMENSION

A-120mm C-22mm E-380mm Wt.-
B-147mm D-145.5mm HOLES-10

Fx 40-116600

MODEL

OEM REFERENCES

SAF 3307116600/3307116601

POSITION

WITH BEARING



Wt.17.700kg

SUITABLE BEARING

KHM 218248/HM 218210

BARE



DIMENSION

A-120mm C-22mm E-270mm Wt.-
B-147mm D-184mm HOLES-

OEM REFERENCES

SAF 3307205600/3307300700

Fx 40-205600

MODEL

POSITION

BARE



DIMENSION

A-138mm C-22mm E-380mm Wt.-
B-138mm D-156mm HOLES-10

OEM REFERENCES

SAF 3307304500/3307304501/
3307304502

Fx 40-304500

MODEL

SUITABLE BEARING

570530. H195/808918/
SET-1370/ 566830.H195

BARE



DIMENSION

A-110mm C-22mm E-270mm Wt.-15.700 Kg
B-130mm D-191mm HOLES-10 M115X2

Fx 11-227200

MODEL

NRS ../ NRZ ../ NHS ../ NHZ
N Series (SN 30..)
N..L Series (SN 30..)
N..LL Series (SN 30..)

OEM REFERENCES

BPW 0327227200

SUITABLE BEARING

33116/32310

BARE



DIMENSION

A-110mm C-22mm E-270mm Wt.-15.500 Kg
B-130mm D-130mm HOLES-10 M125X2

Fx 11-227410

MODEL

ECO PLUS,
K Series (SN 36), N Series (SN 30)
K..LL Series (SN 36), N..LL Series (SN 30)
K..L Series (SN 36), N..L Series (SN 30)

OEM REFERENCES

BPW 0327227410/0980106500 S1

SUITABLE BEARING

32310/33116

BARE



DIMENSION

A-110mm C-22mm E-270mm Wt.-17.000 Kg
B-130mm D-193mm HOLES-10

OEM REFERENCES

BPW 0327227480/ 0980106540 S

Fx 11-227480

MODEL

ECO PLUS ÇAKMA
K Series (SN 36), N Series (SN 30)
K..LL Series (SN 36),
N..LL Series (SN 30), N..L Series (SN 30)

9 Tones

BARE



DIMENSION

A-120mm C- E-270mm Wt.-14.000Kg
B-150mm D-205mm HOLES-10

OEM REFERENCES

BPW 0327244210/0327244300/
0327244170

Fx 11-244210

MODEL

NRS../NRZ../NHS../NHZ
N Series (SN 30), N..LL Series (SN 30)
N..L Series (SN 30)

SUITABLE BEARING

33213/33118

BARE



DIMENSION

A-120mm C-22mm E-270mm Wt.-14.000 Kg
B-150mm D-205mm HOLES-10

OEM REFERENCES

BPW 0327244240/0327227200/
0327244210/0327248320
MB 9763561101/9463560201/
3463560301/6233340001
FUWA 3601A/3601B/3601C/3601E/
3601R/3601S/3601Q
MAN 8335701052/81443013146/
81357013128/81357013152

WITH BEARING

SUITABLE BEARING

33213/33118

Fx 11-244240

MODEL

KH../KR..ECO
K Series (SN 36.), K..L Series (SN 36)
K..LL Series (SN 36)

POSITION



10-12 Tones
M125x2/205

BARE



DIMENSION

A-120mm C-22mm E-270mm Wt.-14.000 Kg
B-150mm D-206mm HOLES-10 M135X2

OEM REFERENCES

BPW 0327244340/ 0980106520 S

Fx 11-244340

MODEL

K Series (SN 36), N Series (SN 30)
K..LL Series (SN 36), N..LL Series (SN 30)
K..L Series (SN 36), N..L Series (SN 30)

SUITABLE BEARING

33118/33213

BARE



DIMENSION

A-120mm C-22mm E-270mm Wt.-14.000 Kg
B-150mm D-206mm HOLES-10 M136X2.5

OEM REFERENCES

BPW 0327244400/ 0980106560 S

Fx 11-244400

MODEL

H Series (SN 42), N Series (SN 30)
K..LL Series (SN 36), N..LL Series (SN 30)
K..L Series (SN 36), N..L Series (SN 30)

SUITABLE BEARING

33118/33213

BARE



DIMENSION

A-110mm C-22mm E-320mm Wt.-17.000 Kg
B-130mm D-193mm HOLES-8 M125X2

OEM REFERENCES

BPW 0327228560

Fx 11-228560

SUITABLE BEARING

33116/32310

9 Tones

BARE



DIMENSION

A-120mm C-22mm E-380mm Wt.-22.250 Kg
B-150mm D-224mm HOLES-10 M136X2.5

OEM REFERENCES

BPW 0327243140/0327243141/
0327243142/0980106580/
03272431602

Fx 11-243140

MODEL

SKH Series (SB 3745)
SH..LL Series (SB 4309/SB 4345)
SKH..LL Series (SB 3745)

SUITABLE BEARING

33213/33118

12 Tones (For Break Disc)

BARE



DIMENSION

A-110mm C-22mm E-380mm Wt.-27.300 Kg
B-130mm D-217mm HOLES-10 M125X2

OEM REFERENCES

BPW 0327230990/ 0327230990 S

Fx 11-230990

MODEL

SKH Series (SB 3745)
SKH..LL Series (SB 3745)

SUITABLE BEARING

33116/32310

BARE



DIMENSION

A-120mm C-22mm E-380mm Wt.-20.000 Kg
B-150mm D-194mm HOLES-10

OEM REFERENCES

BPW 0127243280/098107320/
0327243280/0980107320 S

Fx 11-243280

MODEL

SH..LL Series (SB 4309 / SB 4345)
SKH..LL Series (SB 3745)

SUITABLE BEARING

33213/33118

BPW

WHEEL HUB

FOX[®]

B E A R I N G S

BARE



DIMENSION

A-120mm	C-22mm	E-320mm	Wt.-
B-150mm	D-205mm	HOLES-	M125X2

Fx 11-246110

MODEL

K Series (SN 36), K..LL Series (SN 36)
K..L Series (SN 36)

OEM REFERENCES

BPW 0327246110

12 Tones

BARE



DIMENSION

A-110mm	C-22mm	E-378mm	Wt.-
B-130mm	D-210mm	HOLES-	M115X3

Fx 11-230310

MODEL

OEM REFERENCES

BPW 0327230310/0327230190

9 Tones

BARE



DIMENSION

A-110mm C-22mm E-380mm Wt.-18.500 Kg
B-130mm D-194mm HOLES-10 M115X2

OEM REFERENCES

BPW 0327230340/0327230350/
0327230620/0327230410

WITH BEARING



6,5-9 Tones

SUITABLE BEARING

33116/32310

Fx 11-230340

MODEL

H Series (SN 42..)
H..LL Series (SN 42..)
H (M)..L Series (SN 42..)

POSITION

REAR AXLE

BARE



DIMENSION

A-110mm C-22mm E-380mm Wt.-21 Kg
B-130mm D-194mm HOLES-10 M125X2

OEM REFERENCES

BPW 0327230810

Fx 11-230810

POSITION

REAR AXLE

SUITABLE BEARING

32310/33116

BARE



DIMENSION

A-110mm C-22mm E-380mm Wt.-19 Kg
B-130mm D-194mm HOLES-10 M135X2

OEM REFERENCES

BPW 0327230950/0327230970/
0980106050 S

SUITABLE BEARING

32310/33116

Fx 11-230950

MODEL

HS..ECO MAXX
H Series (SN 42..), SH Series (SB 4345)
SKH Series (SB 3745), H..LL Series (SN 42)
H (M)..L Series (SN 42),
SKH..LL Series (SB 3745)

POSITION

REAR AXLE

BPW

WHEEL HUB

FOX[®]

BEARINGS

BARE



Fx 11-230410

DIMENSION

A-110mm C-22mm E-380mm Wt.-18.50 Kg
B-130mm D-194mm HOLES-10 M115X2

MODEL

HS.-HZ..

OEM REFERENCES

BPW 0327230410/0327230620/
0327230350

POSITION

REAR AXLE

SUITABLE BEARING

33116/32310

TONS

9 ton

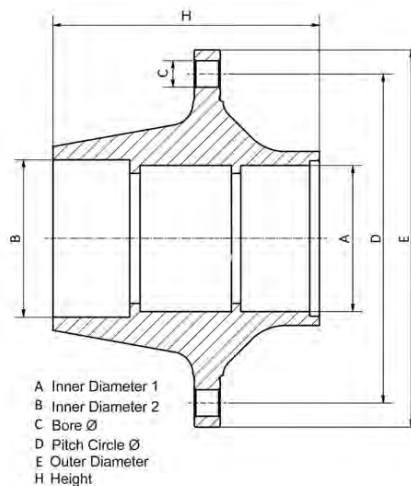

BARE



DIMENSION

A-110mm C-22mm E-380mm Wt.-22 Kg
B-130mm D-210mm HOLES-10 M115X3

OEM REFERENCES

BPW - 0327230300/0327230070/
0327230050/0327230380/
SETRA - 8241000482

Fx 11-230300

POSITION

REAR AXLE

SUITABLE BEARING

33116/32310

BARE



DIMENSION

A-110mm C-22mm E-380mm Wt.-18.400
B-130mm D-194mm HOLES- M125X2

OEM REFERENCES

BPW 0327230870/0327230810/
0980106030

Fx 11-230870

MODEL

HS..ECO - HZ..ECO
H Series (SN 42)
H..LL Series (SN 42)
H (M)..L Series (SN 42)

SUITABLE BEARING

33116/32310

BARE



DIMENSION

A-120mm C-22mm E-380mm Wt.-19 Kg
B-150mm D-205mm HOLES-10 M125X2

Fx 11-248460

MODEL

HS.. - HZ..
H Series (SN 42), H..LL Series (SN 42)
H (M)..L Series (SN 42)

OEM REFERENCES

BPW 0327248460/0327248400/
0327248620/0327248450/
0327248390

POSITION

REAR AXLE

SUITABLE BEARING

33213/33118

10-12 Tones

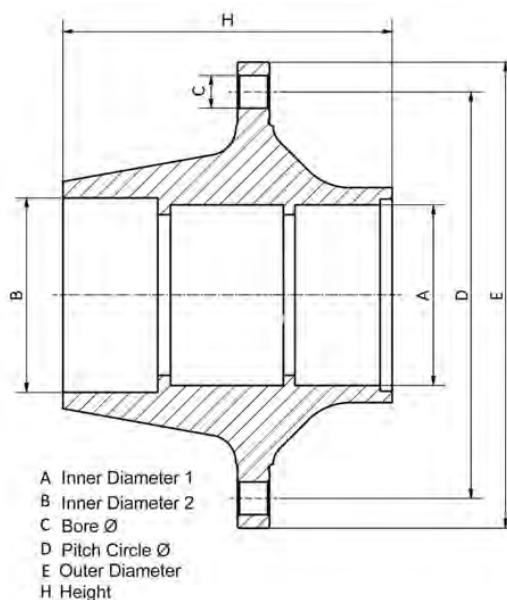

BARE



Fx 11-248320

DIMENSION

A-120mm C-22mm E-380mm Wt.-21 Kg
B-150mm D-220mm HOLES-10 M125X3

MODEL

HS..-HZ..

OEM REFERENCES

BPW 0327248320/0BP327248070/
0327248100/0327248120

POSITION

REAR AXLE

SUITABLE BEARING

33217/33213

12 Tones

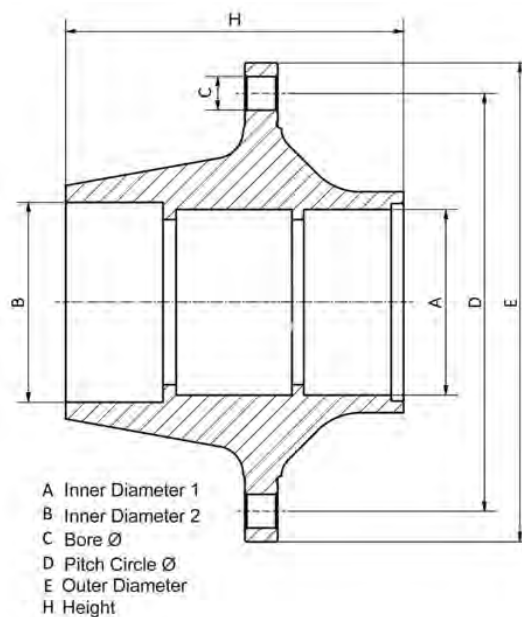

BARE



DIMENSION

A-120mm C-22mm E-380mm Wt.17 Kg
B-150mm D-180mm HOLES-10 M136X2.5

Fx 11-243100

MODEL

H Series (SN 42..), K Series (SN 36..)
SH Series (SB 4345),
SKH Series (SB 3745)
H..LL Series (SN 42..)
SH..LL Series (SB 4309 /SB 4345)
SKH..LL Series (SB 3745)

OEM REFERENCES

BPW 0327243100/0327243102 S/
0980106070 S

POSITION

WITH BEARING



12 Tones

SUITABLE BEARING

33118/33213

BARE



DIMENSION

A-120mm C-22mm E-380mm Wt-.17 Kg
M135X2.5

B-150mm D-180mm HOLES-10

Fx 11-232050

MODEL

HS..ECOPLUS -HZ..ECOPLUS
H Series (SN 42..)
K Series (SN 36..)
H..LL Series (SN 42..)
SKH..LL Series (SB 3745

OEM REFERENCES

BPW 0327232050/ 0327232050 S

SUITABLE BEARING

33118/33213

BARE



DIMENSION

A-120mm C-22mm E-380mm Wt.22 Kg
M135X2

B-150mm D-206mm HOLES-10

Fx 11-248780

MODEL

HS..ECO MAXX

OEM REFERENCES

BPW 0327248780/0980106040/
0980106720

SUITABLE BEARING

33213/33118

BARE



DIMENSION

A-120mm C-22mm E-380mm Wt.-20 Kg
B-150mm D-206mm HOLES-10 M136X2.5

OEM REFERENCES

BPW 0327243120/0980106060/
0327243232/0980106082

Fx 11-243120

MODEL

HS..ECO MAXX - HZ..ECO
H Series (SN 42..)
H..LL Series (SN 42..)
H (M)..L Series (SN 42..)

SUITABLE BEARING

33213/33118

BARE



DIMENSION

A-120mm C-22mm E-380mm Wt.19.500 Kgs
B-150mm D-206mm HOLES-10 M136X2.5-

OEM REFERENCES

BPW 0327243200/ 0327248780
0980106040 S/ 0980106720 S

Fx 11-243200

MODEL

HS..ECO - HZ..ECO
H Series (SN 42), H..LL Series (SN 42)
H (M)..L Series (SN 42)

SUITABLE BEARING

33213/33118

BARE



DIMENSION

A-120mm C-22mm E-380mm Wt.-21 Kg
B-150mm D-220mm HOLES- M125X2

OEM REFERENCES

BPW 0327248330/0327248170/
0327248350

WITH BEARING



12 Tones

SUITABLE BEARING

33213/33217

Fx 11-248330

MODEL

PNEUMATIC BALL

POSITION

BPW

WHEEL HUB

FOX[®]

BEARINGS

BARE



DIMENSION

A-120mm C-22mm E-380mm Wt.
B-150mm D-380mm HOLES-10 M-125X2

Fx 11-248520

MODEL

H Series (SN 42..)
H..LL Series (SN 42..)
H (M)..L Series (SN 42..)

OEM REFERENCES

BPW 0327248520

POSITION

WITH BEARING



12 Tones

SUITABLE BEARING

33118/33213

BARE



DIMENSION

A-130mm C-22mm E-380mm Wt.-27 kg
B-170mm D-223mm HOLES-10 M135X3

OEM REFERENCES

BPW 0327262270/0327262190/
0327262200

Fx 11-262270

MODEL

HS.. - HZ..
H Series (SN 42)
H (M)..L Series (SN 42)

SUITABLE BEARING

32218/33215

BARE



DIMENSION

A-120mm C-22mm E-335mm Wt.19.850 Kg
B-150mm D-280.8mm HOLES-10 M136X2

OEM REFERENCES

BPW - 0327248970/0327243120/
0327248950/0980106060/
0327243232/0980106082

Fx 11-248970

MODEL

SUITABLE BEARING

33213/33118

BPW

WHEEL HUB

FOX[®]

BEARINGS

BARE



DIMENSION

A-150mm C-22mm E-380mm Wt.-35 Kg
B-200mm D-285mm HOLES-10 M155X3

OEM REFERENCES

BPW - 0327280860/0327280060/
0327280070/0327280180/
0327286100/0327280100/
0327280190/0327280140

WITH BEARING



16 Tones

SUITABLE BEARING

32314/32222

Fx 11-280860

MODEL

H Series (SN 42..)

POSITION

BARE



DIMENSION

A-130mm C-22mm E-335mm Wt.-26.200 Kg
B-170mm D-280.80mm HOLES-10

OEM REFERENCES

BPW 0327262350

Fx 11-262350

MODEL

BARE



DIMENSION

A-120mm C- E-285mm Wt.-
B-150mm D-220mm HOLES-8 M136X2.5

OEM REFERENCES

BPW 0327247330/
0980106130 S 0980106140 S

Fx 11-247330

MODEL

H Series (SN 42..)

POSITION

BPW

WHEEL HUB

FOX[®]

BEARINGS

BARE



DIMENSION

A-120mm C-22mm E-380mm Wt.-19.740
B-150mm D-180mm HOLES-10

Fx 11-243290

MODEL

SH Series (SB 4345),
SKH Series (SB 3745)
SH..LL Series (SB 4309 / SB 4345)
SKH..LL Series (SN SB 3745)

OEM REFERENCES

BPW 0327243290

POSITION

WITH BEARING



8-9 TONS

SUITABLE BEARING

33118/33213

BARE



DIMENSION

A-120mm C-22mm E-335mm Wt.-
B-150mm D-280.8mm HOLES-10 M136X2.5

OEM REFERENCES

BPW 0327243222

Fx 11-243222

MODEL

SH Series (SB 4345)
SH..LL Series (SB 4309 / SB 4345)

10-12 TONS

BARE



DIMENSION

A-120mm C-22mm E-320mm Wt.-14.800 Kg
B-150mm D-180mm HOLES-10

OEM REFERENCES

BPW 0327246330

11-246330

MODEL

SKH Series (SB 3745)
SKH..LL Series (SN SB 3745)

8-9 TONS

BPW

WHEEL HUB

FOX[®]

BEARINGS

BARE



DIMENSION

A-120mm C-22mm E-335mm Wt.-
B-150mm D-280.8mm HOLES-10

OEM REFERENCES

BPW 0327248970

Fx 11-248970

MODEL

H Series (SN 42..)
H..LL Series (SN 42..)
H (M)..L Series (SN 42..)

10/12 Tons

BARE



DIMENSION

A-120mm C-22mm E-275mm Wt.-15.300 Kg
B-150mm D-206mm HOLES-8 M136X2.5

OEM REFERENCES

BPW 0327246280/0980106690 S/
0327246282

Fx 11-246280

MODEL

K Series (SN 36..)
SKH Series (SB 3745)
SKH..LL Series (SB 3745)

SUITABLE BEARING

33213/33118

BARE



DIMENSION

A-120mm C-22mm E-335mm Wt.-
B-150mm D-280.8mm HOLES-

OEM REFERENCES

BPW 0327243262

Fx 11-243262

MODEL

SH Series (SB 4345)
SH..LL Series (SB 4309 / SB 4345)

POSITION

BARE



DIMENSION

A-120mm C-22mm E--275mm Wt.-
B-150mm D-220.5mm HOLES-

OEM REFERENCES

BPW 0327246302

Fx 11-246302

MODEL

SH Series (SB 4345)
SH..LL Series (SB 4309 / SB 4345)

POSITION

BARE



DIMENSION

A-130mm C--22mm E-335mm Wt.-
B-170mm D-280.8mm HOLES- M150X2

OEM REFERENCES

BPW 0327262350

Fx 11-262350

MODEL

TONS

14 Tons

BARE



DIMENSION

A-175.5mm C--22mm E- Wt.-
B-223mm D-27mm HOLES-

OEM REFERENCES

BPW 0327263060/0327263080/
0327263120

Fx 11-263060

MODEL

N Series (SN 30..)
N..LL Series (SN 30..)
N..L Series (SN 30..)

TONS

13-14 Tons

BARE



Fx 11-228350

DIMENSION

A-220.5mm C-22mm E- Wt.16.60 Kg-
B-275mm D- HOLES-8

MODEL

K Series (SN 36..)

OEM REFERENCES

BPW 0327228350

POSITION

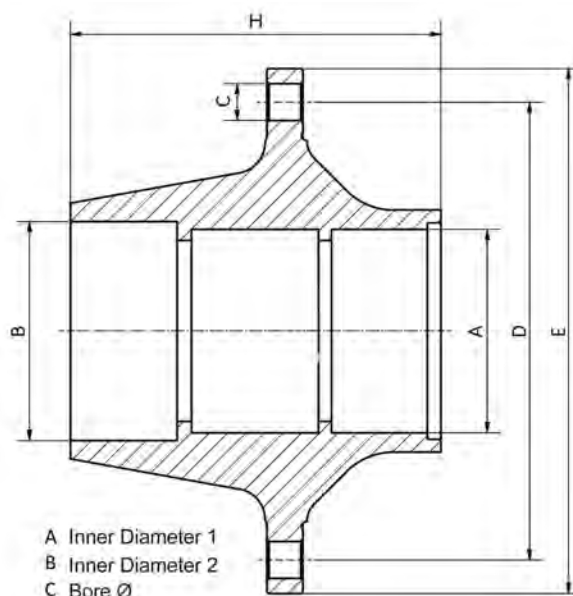

A Inner Diameter 1
B Inner Diameter 2
C Bore Ø
D Pitch Circle Ø
E Outer Diameter
H Height

BARE



DIMENSION

A-127mm C-22.25mm E-381mm Wt.-29 Kg
B-127.3mm D-192.5mm HOLES-10

Fx 06-868663

MODEL

RG SERIES

OEM REFERENCES

SCANIA 1868663/1480933/1724406/
1391369/1866430

POSITION

WITH BEARING



Wt.35 Kg

SUITABLE BEARING

BTH 0018

BARE



DIMENSION

A-147mm C-24mm E-380mm Wt.-27.340 Kg
B-147mm D-213.50mm HOLES-10

OEM REFERENCES

SCANIA 1800283/1382884

WITH BEARING



Wt.33.380 Kg

SUITABLE BEARING

KHM-218248/HM 218210

Fx 06-800283

MODEL

RG SERIES

POSITION

BARE



DIMENSION

A-147mm C-22.3mm E-380mm Wt.-28 Kg
B-147mm D-213.50mm HOLES-10

Fx 06-724790

MODEL

RG SERIES

OEM REFERENCES

SCANIA 1724790

POSITION

WITH BEARING



Wt.35.800kg

SUITABLE BEARING

KHM 218248/HM 218210

BARE



Fx 06-379188

DIMENSION

A-100mm C-22mm E-375mm Wt.-
B-130mm D-145mm HOLES-10

MODEL

H SERIES OLD MODEL

OEM REFERENCES

SCANIA 379188/397186/562051

POSITION

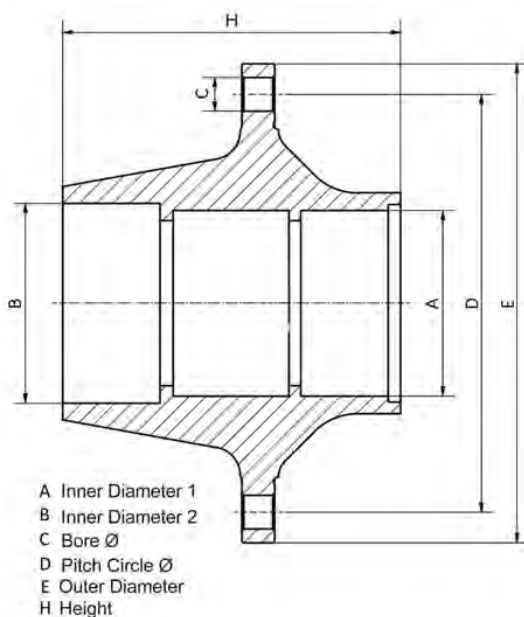

BARE



DIMENSION

A-127.3mm C-22.3mm E-375mm Wt.-25 kg
B-127mm D-132mm HOLES-10

Fx 06-868674

MODEL

R SERIES

OEM REFERENCES

SCANIA 1868674/1414154/
1382774/1371596/1724407

POSITION

WITH BEARING



(For Drum)
Wt.32.360 Kgs

SUITABLE BEARING

BTH 0018B

BARE



Fx 06-337565

DIMENSION

A-146.9mm C-22.3mm E-375mm Wt.-29.300 Kg
B-146.9mm D-335mm HOLES-10

MODEL

HR SERIES

OEM REFERENCES

SCANIA 337565/255348/347945/
255348/1724788

POSITION

WITH BEARING



CAMPAIGN PULLING
Wt.34.720kg

SUITABLE BEARING

KHM 218248/HM 218210

BARE



DIMENSION

A-130mm C-22.4mm E-375mm Wt.-23.7010 Kg
B-140mm D-184mm HOLES-10

Fx 06-337563

MODEL

OEM REFERENCES

SCANIA 337563

POSITION

REAR

WITH BEARING



Wt.29.130kg

SUITABLE BEARING

32216/33215

BARE



DIMENSION

A-112.7mm C-27.2mm E-383mm Wt.-29.750 Kg
B-130mm D-185mm HOLES-10

OEM REFERENCES

VOLVO 1626994/20374418

WITH BEARING



Wt.33.960kg

SUITABLE BEARING

39580/39520 , JF7049A/JF7010

Fx 16-626994

MODEL

F SERIES

POSITION

VOLVO

WHEEL HUB

FOX[®]

BEARINGS

BARE



DIMENSION

A-148mm C-25.300mm E-385.50mm Wt.-31.500 Kg
B-148mm D-157mm HOLES-10

OEM REFERENCES

VOLVO 20535207/20819804/
1075408/20820402/1075428/
1076526
RENAULT- 7420819806/
7421328181

WITH BEARING



Wt.31,566kg

SUITABLE BEARING

566425.H195

Fx 16-535207

MODEL

VOLVO CERLI CAMPAIGN
(25mm wheel bolt)

POSITION

VOLVO

WHEEL HUB

FOX[®]

BEARINGS

BARE



DIMENSION

A-125mm C-25mm E-384mm Wt.-22.820 Kg
B-125mm D-164.5mm HOLES-10

Fx 16-024160

MODEL

H-16 CONSTRUCTION
VEHICLES

OEM REFERENCES

VOLVO-21024160/21024166/
20518092 20534905/74535202
RENAULT-7420534904/74210214160

POSITION

WITH BEARING



Wt.26.730 Kg

SUITABLE BEARING

566426.H195

BARE



DIMENSION

A-125mm C-27.2mm E-383mm Wt.-29.220Kg
B-125mm D-165.5mm HOLES-10

OEM REFERENCES

VOLVO 3988930/85114471/
85111794/3989341/8510818/
85105693

WITH BEARING



Wt.34.040kg

SUITABLE BEARING

566426.H195

Fx 16-988930

MODEL

FM 7 1998-2001, FH 12 1998-2005,
FH 16 1998-2003, FM 10,
FM 12 1998-2005

POSITION

VOLVO

WHEEL HUB

FOX[®]

BEARINGS

BARE



DIMENSION

A-125mm C-25mm E-383mm Wt.-29.200 Kgs
B-125mm D-165.5mm HOLES-10

Fx 16-026798

MODEL

FH12 OLD MODEL
FRONT POINTS

OEM REFERENCES

VOLVO 1026798/20252417/20535202/
85107750/85111448 8514470/
85111791/21024206
RENAULT -7420535202/7421024206/
7421116569/7485114470

POSITION

TRAILING AXLE

WITH BEARING



Wt.34,140kg

SUITABLE BEARING

566426.H195

BARE



DIMENSION

A-148mm C-27.2mm E-383.4mm Wt.33,040 Kg
B-148mm D-270mm HOLES-10

Fx 16-516966

MODEL

FH 12 2001-2005, FH 16 1998-2006,
FM 9 2001-2005, FM 10, FM 12
2001-2005

OEM REFERENCES

VOLVO 20516966/20535263/
85107753/85105696/3092720/
85104298

POSITION

WITH BEARING



Wt.38,360 kg

SUITABLE BEARING

566425.H195

BARE



DIMENSION

A-148mm C-27.2mm E-385.5mm Wt.-26 Kg
B-148mm D-157mm HOLES-10

Fx 16-517164

MODEL

FM 7 1998-2001, FH 12 1998-2005,
FH 16 1998-2006, FM 9 2001-2005,
FM 10, FM 12 1998-2005, NH 12

OEM REFERENCES

VOLVO 20517164/1078053/
85104301

POSITION

WITH BEARING



Wt.33,000 kg

SUITABLE BEARING

566425.H195

VOLVO

WHEEL HUB

FOX[®]

BEARINGS

BARE



DIMENSION

A-110mm C-27.2mm E-383.5mm Wt.26.400 Kg-
B-110mm D-160mm HOLES-10

Fx 16-111792

MODEL

FH 12 2001-2005, FH 16 2003-2006,
FM 9 2001-2005, FM 12 2001-2005

OEM REFERENCES

VOLVO 85111792/85105692

POSITION

FRONT

WITH BEARING



(For Break Disc)
Wt.29,900 kg

SUITABLE BEARING

566427.H195

BARE



DIMENSION

A-148mm C-27.20mm E-384mm Wt.-22,840Kg
B-148mm D-172.5mm HOLES-10

Fx 16-943982

MODEL

FL 6 1996-2000, FL 7 1985-2000, FM 7
1998-2001, FL 10/12, FH 12 1993-2005,
FH 16 1993-2006, FM 9 2001-2005, FM
10, FM 12 1998-2005, NH 12

OEM REFERENCES

VOLVO 3943982/20476519/
20518054/ 20517950 /20517952

POSITION

WITH BEARING



(For Break Disc)
Wt.28,840 kg

SUITABLE BEARING

566425.H195

BARE



DIMENSION

A-125mm C-27.2mm E-384mm Wt.-24,260 kg
B-125mm D-164.5mm HOLES-10

Fx 16-518092

MODEL

FM 7 1998-2001
FH 12 1998-2005, FH 16
1998-2006, FM 9 2001-2005,
FM 10, FM 12 1998-2005, NH 12

OEM REFERENCES

VOLVO 20518092/21024155

POSITION

WITH BEARING



(For Break Disc)
Wt.27,320 kg

SUITABLE BEARING

566426.H195

FORD

WHEEL HUB

FOX[®]

BEARINGS

BARE



DIMENSION

A-127.3mm C-22.3mm E-375mm Wt.-24.950Kg
B-127mm D-132mm HOLES-10

Fx 08-724407

MODEL

32 / 30-32 / 34-25 / 24 CARGO
(CAMPAIGN TOP)

OEM REFERENCES

FORD 1724407/1414154

POSITION

WITH BEARING



Wt.32.360 Kg

SUITABLE BEARING

BTH 0018B

FORD

WHEEL HUB

FOX[®]

BEARINGS

BARE



DIMENSION

A-93.2mm C-25mm E-380.5mm Wt.-
B-132mm D-147mm HOLES-10

Fx 08-CT1106

MODEL

32/30-25/24 CARGO

OEM REFERENCES

FORD 98CT1106/RFC1106AB

POSITION

FRONT

WITH BEARING



VOLVO

WHEEL HUB

FOX[®]

BEARINGS

BARE



DIMENSION

A-148mm C-25.3mm E-385.5mm Wt.-25,680 kg
B-148mm D-157mm HOLES-10

Fx 16-819804

MODEL

Premium II TR/PR/ DXi 7,
Kerax DXi 11/13, K
FH 12 2001-2005, FH 16 2003-2006,
FM 9 2001-2005, FM 12 2001-2005,
FH/FM 2005-, FMX, NH 12

OEM REFERENCES

VOLVO 20819804/1075408/
20820402/1075428/21328177/
21328181/20535207
RENAULT - 7421328181/7
420819806

POSITION

WITH BEARING



Wt.31,566 kg

RENAULT

WHEEL HUB

FOX[®]

BEARINGS

BARE



DIMENSION

A-150mm C-25mm E-376.5mm Wt.-31.953 Kg
B-160mm D-235mm HOLES-10

Fx 30-566112

MODEL

KERAX E.M.(370)

OEM REFERENCES

RENAULT 5010566112/5000682333

POSITION

WITH BEARING



Wt.39,980 kg

SUITABLE BEARING

JF9549/JF9510,VKHB 2337

BARE



DIMENSION

A-110mm C-27mm E-383mm Wt.-26.400 Kg
B-110mm D-160mm HOLES-10

OEM REFERENCES

RENAULT 7421021381/7410241087

Fx 30-021381

MODEL

PREMIUM TR

SUITABLE BEARING

566427.H195

BARE



DIMENSION

A-150mm C-20.5mm E-313mm Wt.-
B-150mm D-211mm HOLES-8

OEM REFERENCES

RENAULT 5010241087

Fx 30-241087

MODEL

POSITION

LIFT AXLE

RENAULT

WHEEL HUB



BARE



Fx 30-517167

DIMENSION

A-148mm C-27mm E-385mm Wt.-25.800 Kg
B-148mm D-157mm HOLES-10

MODEL

KERAX 6X4 HANDLE OLD MODEL

OEM REFERENCES

RENAULT 7420517167/1026661/
5001861915

POSITION

WITH BEARING



Wt.33 Kg

SUITABLE BEARING

566425.H195

RENAULT

WHEEL HUB

FOX[®]

BEARINGS

BARE



Fx 30-022433

DIMENSION

A-110mm C-25mm E-384mm Wt.-26.500 Kg
B-110mm D-162mm HOLES-10

MODEL

KERAX 6X4 HANDLE OLD MODEL

OEM REFERENCES

RENAULT 7421022433/7485111789
VOLVO - 85107749/85111789

POSITION

WITH BEARING



Wt.30.020 Kg

SUITABLE BEARING

566427.H195

BARE



DIMENSION

A-152.4mm C-25.5mm E-375mm Wt.-25.360 Kg
B-152.4mm D-230.5mm HOLES-10

OEM REFERENCES

FRUEHAUF AJB 0038001/
CF-1014228/448057

Fx 42-038001

MODEL

LONG TYPE

SUITABLE BEARING

KHM518445/HM518410

BARE



DIMENSION

A-147mm C-25.5mm E-265mm Wt.-
B-147mm D-152mm HOLES-10

OEM REFERENCES

FRUEHAUF M006077/CF103079

Fx 42-006077

MODEL

POSITION

BARE



DIMENSION

A-147mm C-25.5mm E-376mm Wt.-19.580 Kg
B-147mm D-152mm HOLES-10

OEM REFERENCES

FRUEHAUF M007851/CF1031007

Fx 42-007851

MODEL

SUITABLE BEARING

BT18639416A/Q

BARE



DIMENSION

A-130mm C-25.5mm E-371.50mm Wt.-22.800 Kg
B-145mm D-172mm HOLES-10

OEM REFERENCES

FRUEHAUF 6502795D/0018321C

Fx 42-02795D

MODEL

TRAILOR

POSITION

FRUEHAUF

WHEEL HUB

FOX[®]

BEARINGS

BARE



DIMENSION

A-147mm C-25.50mm E-376mm Wt.-19.800Kg

B-147mm D-152mm HOLES-10

Fx 42-031007

MODEL

OEM REFERENCES

FRUEHAUF CF1031007/
M006050/449557/449629/M007851

POSITION

WITH BEARING



SUITABLE BEARING

BT18639416A/Q

MAN

WHEEL HUB

FOX[®]

BEARINGS

BARE



DIMENSION

A-72mm C-18mm E-290mm Wt.-15.00 Kg
B-100mm D-139mm HOLES-6

Fx 22-010169

MODEL

12/153

OEM REFERENCES

MAN 81443010169/81443013156/
81443010174

POSITION

FRONT

WITH BEARING



(For Brake Disc)
Wt.17.100 Kg

SUITABLE BEARING

32207/BT1B 328251

MAN

LIFT AXLE WHEEL HUB

FOX[®]

BEARINGS

BARE



DIMENSION

A-160mm C-22mm E-380mm Wt.-24.870 Kg
B-160mm D-163mm HOLES-10

Fx 22-010155

MODEL

18/430 TGA - MEGA FORTUNA

OEM REFERENCES

MAN 81357010155/81357013155

POSITION

WITH BEARING



(For Brake Disc)
Wt.32.940 Kg

SUITABLE BEARING

803750B

MAN

LIFT AXLE WHEEL HUB

FOX[®]

B E A R I N G S

BARE



DIMENSION

A-180mm C-22mm E-369mm Wt.-32.600 Kg
B-170mm D-200.5mm HOLES-10

Fx 22-010141

MODEL

26/230-26/270-26/321-33/372-
SL/232-SG/220-19/320

OEM REFERENCES

MAN 81357010141/81357010086

POSITION

WITH BEARING



Wt.41.200 Kg

SUITABLE BEARING

30220/33022

BARE



DIMENSION

A-72mm C-18mm E-290mm Wt.-13.300 Kg
B-100mm D-140mm HOLES-6

OEM REFERENCES

MAN 81443010182

Fx 22-010182

MODEL

12/163

SUITABLE BEARING

33207/JR,BT1B 328251

BARE



DIMENSION

A-115mm C-18mm E-290mm Wt.-
B-130mm D-202mm HOLES-

OEM REFERENCES

MAN 81357013147/ 81357010147

Fx 22-013147

MODEL

POSITION

REAR

BARE



DIMENSION

A-170mm C-22mm E-158.5mm Wt.26.500 Kg-
B-170mm D-158.5mm HOLES-10

Fx 22-006150

MODEL

TGA*TGS

OEM REFERENCES

MAN 81357006150/81357013174/
81357006136/81357010174

POSITION

WITH BEARING



Wt.35.240 Kg

SUITABLE BEARING

804162A

MAN

WHEEL HUB

FOX[®]

BEARINGS

BARE



DIMENSION

A-145mm C-22mm E-369mm Wt.-
B-160mm D-228mm HOLES-

OEM REFERENCES

MAN 81357010111/81357010159/
81357010142

Fx 22-010111

MODEL

POSITION

BARE



DIMENSION

A-145mm C-22mm E-369mm Wt.-
B-160mm D-211mm HOLES-

OEM REFERENCES

MAN 81357010126/81357010140/
81357013126

Fx 22-010126

MODEL

POSITION

BARE



DIMENSION

A-	C-	E-	Wt.-
B-	D-	HOLES-	

OEM REFERENCES

MAN 83443010000/81443010107/
9013022181369

Fx 22-010000

MODEL

POSITION

BARE



DIMENSION

A-180	C-22	E-369	Wt.-
B-170	D-200,5	HOLES-	

OEM REFERENCES

MAN 83357010004/81357010081/
81357010128/81357010028

Fx 22-010004

MODEL

POSITION

MAN

WHEEL HUB

FOX[®]

BEARINGS

BARE



DIMENSION

A-110mm C-22mm E-369mm Wt.-21.7000kg
B-130mm D-189mm HOLES-

Fx 22-010146

MODEL

OEM REFERENCES

MAN 81443010146/81443013146

POSITION

WITH BEARING



Wt.27Kg

SUITABLE BEARING

528983B/32310

BARE



DIMENSION

A-145mm C-22mm E-369mm Wt.-
B-160mm D-230mm HOLES-

OEM REFERENCES

MAN 81357010142/81357010159/
81357013111 8135701015/
8135701011/ 8135701041

Fx 22-010142

MODEL

POSITION

BARE



DIMENSION

A-72mm C-18mm E-290mm Wt.-
B-100mm D-140mm HOLES-

OEM REFERENCES

MAN 8144300182

Fx 22-300182

MODEL

POSITION

MAN

WHEEL HUB

FOX[®]

BEARINGS

BARE



DIMENSION

A-110mm C-22mm E-380mm Wt.-
B-130mm D-187mm HOLES-

OEM REFERENCES

MAN 81443013159/81443010159/
81443010179/81443011759

Fx 22-013159

MODEL

POSITION

BARE



DIMENSION

A-45mm C-22mm E-380mm Wt.-
B-160mm D-383,5mm HOLES-

OEM REFERENCES

MAN 81357013152/81357010151ZF

Fx 22-013152

MODEL

POSITION

BARE



DIMENSION

A-180mm C-22mm E-369mm Wt.-
B-170mm D-217mm HOLES-

OEM REFERENCES

MAN 81357013128

Fx 22-013128

MODEL

POSITION

BARE



DIMENSION

A-130mm C-18mm E-250mm Wt.-
B-130mm D-140mm HOLES-

OEM REFERENCES

81357010161

Fx 22-010161

MODEL

POSITION

MAN

WHEEL HUB

FOX[®]

BEARINGS

BARE



DIMENSION

A-160mm C-22mm E-380mm Wt.-25.200kg
B-160mm D-165mm HOLES-10

OEM REFERENCES

MAN - 81357010176/ 81357016040
NEOPLAN OTOBUS -
ZF- 4474335121/ 36357010000

WITH BEARING



Wt.32.700kg

SUITABLE BEARING

803750B

Fx 22-570101

MODEL

POSITION

MAN

FLANGE

FOX[®]

BEARINGS



DIMENSION

A- C-22mm E-384mm Wt.-15.800kg
B- D-55mm HOLES-

OEM REFERENCES

MAN 81443010195/81443010177

Fx 22-010195

MODEL

POSITION



DIMENSION

A- C-22mm E-369mm Wt.-
B- D-87mm HOLES-

OEM REFERENCES

81443010178

Fx 22-010178

MODEL

POSITION

BARE



DIMENSION

A-140mm C-18mm E-121,5mm Wt.-11.950kg
B-140mm D-290mm HOLES-,

Fx 22-010165

MODEL

OEM REFERENCES

MAN 81357010165

POSITION

WITH BEARING



Wt.18.700kg

SUITABLE BEARING

805003CA

MAN

WHEEL HUB

FOX[®]

BEARINGS

BARE



DIMENSION

A-85mm C-20mm E-322mm Wt.-17kg
B-120mm D-161mm HOLES-

OEM REFERENCES

MAN 81443010176/81443013176

WITH BEARING



SUITABLE BEARING

33209/201010

Fx 22-010176

MODEL

POSITION

MERITOR

WHEEL HUB



BARE



DIMENSION

A-120mm C-22.7mm E-271mm Wt.-
B-147mm D-178mm HOLES-10

OEM REFERENCES

ROR 21203219/14203219

Fx 37-203219

MODEL

DORSE

SUITABLE BEARING

33213/VKHB2029

BARE



DIMENSION

A-147mm C-23.4mm E-376.5mm Wt.-25.240 Kg
B-147mm D-173mm HOL10ES-

OEM REFERENCES

ROR 21226120

Fx 37-226120

MODEL

SUITABLE BEARING

KHM 218248/HM 218210

BARE



DIMENSION

A-120mm C-22.7mm E-378mm Wt.-23.920 Kg
B-147mm D-178mm HOLE10S-

Fx 37-204561

MODEL

OEM REFERENCES

ROR 21204561/21204562/
14204561/14204562

POSITION

WITH BEARING

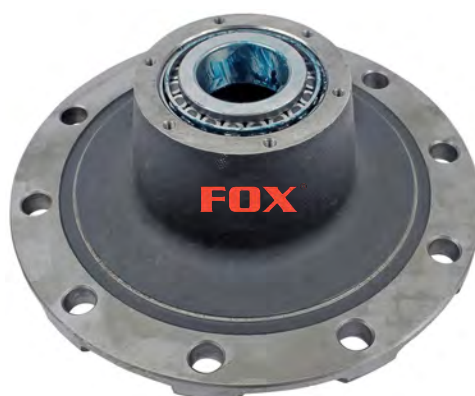

SUITABLE BEARING

33213/HM218248/HM218210

MERITOR

WHEEL HUB



BARE



DIMENSION

A-120mm C-23mm E-271mm Wt.-
B-147mm D-178mm HOLES-10

OEM REFERENCES

ROR 21228120

Fx 37-228120

MODEL

POSITION

BARE



DIMENSION

A-140mm C-23.5mm E-337mm Wt.-
B-140mm D-158mm HOLES-10

OEM REFERENCES

ROR 14225425

Fx 37-225425

MODEL

Y.M.

SUITABLE BEARING

BT1-0163/Q

MERITOR

WHEEL HUB



BARE



Fx 37-226120

DIMENSION

A-147mm C-23.4mm E-376.5mm Wt.-24.4 Kg
B-147mm D-173mm HOLES-10

MODEL

OEM REFERENCES

ROR 14226120

POSITION

WITH BEARING



(For Twin Wheel)
Wt.30 Kg

SUITABLE BEARING

KHM 218248/HM 218210

BARE



DIMENSION

A-120mm C-23.25mm E-375mm Wt.-
B-147mm D-176mm HOLES-

OEM REFERENCES

ROR 21210885 R/14210885

Fx 37-210885

MODEL

Y.M.

SUITABLE BEARING

VKHB 2029

BARE



DIMENSION

A-140mm C-23.15mm E-380mm Wt.-
B-140mm D-179.5mm HOLES-10

OEM REFERENCES

ROR 14227483/21227483

Fx 37-227483

MODEL

NEW MODEL

SUITABLE BEARING

BT1-0127/Q,VKHB 2315

MERITOR

WHEEL HUB



BARE



DIMENSION

A-140mm C-23.5mm E-380mm Wt.-
B-140mm D-158mm HOLES-

OEM REFERENCES

ROR 21225290/14225290

Fx 37-225290

MODEL

NEW MODEL

POSITION

BARE



DIMENSION

A-110mm C-23.5mm E-377mm Wt.-
B-130mm D-202mm HOLES-

OEM REFERENCES

14219784/212211625/21219784/
21220158 (Kit)

Fx 37-219784

MODEL

SUITABLE BEARING

32310/33116

BARE

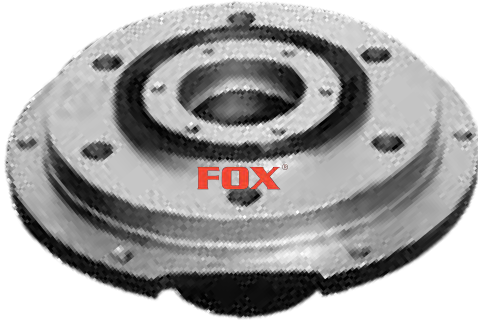

DIMENSION

A-80mm C-18.25mm E-302mm Wt.-
B-100mm D-142mm HOLES-

OEM REFERENCES

IVECO 7168364/4685285

Fx 36-168364

MODEL

85 / 12

POSITION

FRONT

BARE



DIMENSION

A-110mm C-18.25mm E-304mm Wt.-
B-110mm D-199mm HOLES-

OEM REFERENCES

IVECO 7168365/ 4686447

Fx 36-168365

MODEL

SUITABLE BEARING

VKHB 2154

BARE



DIMENSION

A-120mm C-22mm E-374mm Wt.-
B-145mm D-174mm HOLES-

OEM REFERENCES

IVECO 7168588/7169999/7162807/
7168587

Fx 36-168588

MODEL

170.20-26-26T-35-35T -
180.24-24T 190.2026-T-35T - i26 -
i26T - 190.i35-i35T-30-T-P-OT 190.38-
T-P-PT - 220.F35T - 220.38T -
PT-240.30P.38 240.38P - 330.26H-HT-
N - 330.30H-35H-HT-HW

SUITABLE BEARING

VKHB 2002/ VKHB 2203

BARE



DIMENSION

A-150mm C-22mm E-374mm Wt.-
B-190mm D-280mm HOLES-

OEM REFERENCES

7179929/7168464/7181782/
7178829

Fx 36-179929

MODEL

190.33 TURBO STAR

SUITABLE BEARING

VKHB 2080 / VKHB 2212

BARE



DIMENSION

A-120mm C-20mm E-313mm Wt.-
B-150mm D-223mm HOLES-

OEM REFERENCES

7172551

Fx 36-172551

MODEL

EUROCARGO 120E-15

SUITABLE BEARING

VKHB 2137/VKHB 2080

BARE



DIMENSION

A-120mm C-22mm E-374mm Wt.-
B-130mm D-136.5mm HOLES-

OEM REFERENCES

7173327/ 7182031/ 1782032/
7173326

Fx 36-173327

MODEL

EURO TRAKKER

SUITABLE BEARING

VKHB 5343

BARE



Fx 36-104691

DIMENSION

A-180mm C-22mm E-372mm Wt.-
B-190mm D-210mm HOLES-

MODEL

EUROTRUCK

OEM REFERENCES

42104691/42104692

POSITION

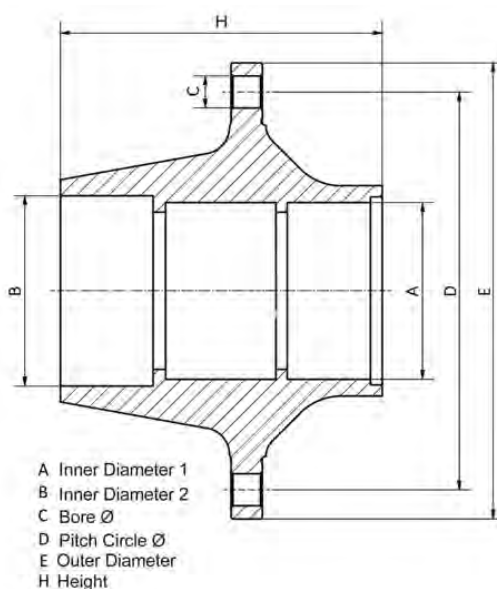

SUITABLE BEARING

VKHB 2216/VKHB 2215

BARE



Fx 36-180909

DIMENSION

A-160mm C-22mm E-370mm Wt.-
B-160mm D-153mm HOLES-

MODEL

EUROTECK

OEM REFERENCES

7180909/ 7179742/ 2996882

POSITION

WITH BEARING

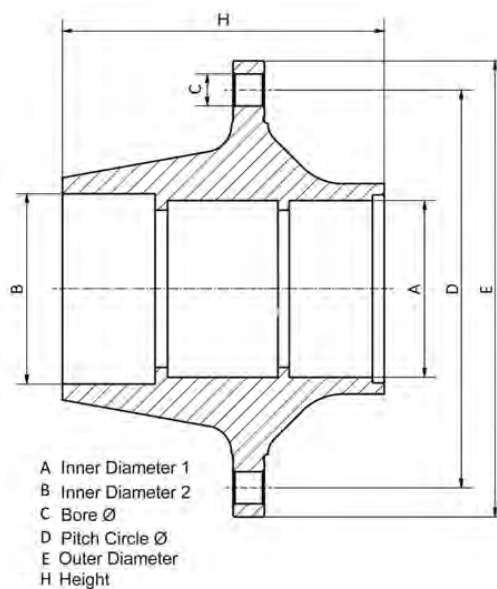

BARE



DIMENSION

A-120mm C-22mm E-383.5 Wt.-
B-130mm D-188.5mm HOLES-10

OEM REFERENCES

7183906/ 7180797/ 7188706

Fx 36-183906

MODEL

170 E 18 - STRALIS

POSITION

BARE



DIMENSION

A-150mm C-22mm E-313mm Wt.-
B-170mm D-240mm HOLES-

OEM REFERENCES

7168593

Fx 36-168593

MODEL

145.17

SUITABLE BEARING

VKHB2080/VKHB 2210

BARE



DIMENSION

A-120mm C-22mm E-380mm Wt.-
B-130mm D-186mm HOLES-

OEM REFERENCES

71733114/ 7173316/ 7173315

Fx 36-733114

MODEL

EUROTECH, EUROCARGO, EUROSTAR

POSITION

BARE

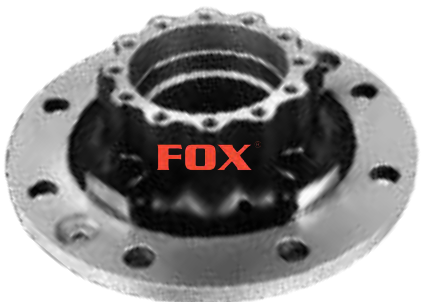

DIMENSION

A-115mm C-21.5mm E-320mm Wt.-
B-115mm D-123mm HOLES-

OEM REFERENCES

7173696

Fx 36-173696

MODEL

EUROCARGO 80/15

SUITABLE BEARING

VKHB 2282

BARE



DIMENSION

A-180mm C-22mm E-372mm Wt.-
B-190mm D-210mm HOLES-

OEM REFERENCES

42101361/ 42037491/ 42101959/
42101918

Fx 36-101361

MODEL

180.24 180.26 190.30 190.38
190i26 190. 35 220.38PT
240.30P 240.38P 330.26 330.30
330.35 330.36 330F26 330F35

SUITABLE BEARING

VKHB 2216/VKHB2215

BARE



DIMENSION

A-180mm C-22mm E-372mm Wt.-
B-190mm D-210mm HOLES-

OEM REFERENCES

42037492

Fx 36-037492

MODEL

POSITION

BARE



DIMENSION

A-160mm C-22mm E-386mm Wt.-
B-160mm D-153mm HOLES-

OEM REFERENCES

7186803

Fx 36-186803

MODEL

STRALIS

POSITION

BARE



DIMENSION

A-160mm C-22mm E-386mm Wt.-
B-160mm D-153mm HOLES-

OEM REFERENCES

71779775/7179777/7186804

Fx 36-779775

MODEL

STRALIS

POSITION

BARE



DIMENSION

A-100mm C-21.5mm E-325mm Wt.-
B-100mm D-160mm HOLES-

OEM REFERENCES

7182046/7172885

Fx 36-182046

MODEL

SUITABLE BEARING

VKHB 2339

BARE



DIMENSION

A-1214mm C-19mm E-250mm Wt.-
B-1214mm D-116mm HOLES-

OEM REFERENCES

7172993

Fx 36-172993

MODEL

SUITABLE BEARING

VKHB 2209

BARE



DIMENSION

A-	C-	E-	Wt.-3.650 Kg
B-	D-	HOLES-	

OEM REFERENCES

93824579/93810034/93824580/
VKBA3553/7136908

Fx 36-VKBA3553

MODEL

IVECO DAILY

POSITION

BARE



DIMENSION

A-160mm	C-22mm	E-372mm	Wt.22 Kg-
B-145mm	D-173.5mm	HOLES-	

OEM REFERENCES

42115016

Fx 36-1150156

MODEL

IVECO EURO TRACK 4X4 PORYA

SUITABLE BEARING

33019/33021

GIGANT

WHEEL HUB

FOX[®]

BEARINGS



Fx 36-VKBA3553

DIMENSION

A-	C-	E-	Wt.-22.800 Kg
B-	D-	HOLES-	

MODEL

GKH2 3020

OEM REFERENCES

709317876/09317876
BEARING:9272681/9272778

POSITION



STUD OEM REFERENCES

GI09226008/709226008
M22X1.5X100mm



NUT OEM REFERENCES

708606072
M22X1.5,H:27,SW:32

SCANIA

REP. KIT, WHEEL HUB

FOX[®]

BEARINGS



DIMENSION

A-110.20	C-146	E-	Wt.-9.10 kg
B-170	D-	HOLES-	

OEM REFERENCES

SCANIA 1817256/2117621

Fx-06-581863

VKBA 5455

MODEL

POSITION

REAR

FOX[®]

B E A R I N G S

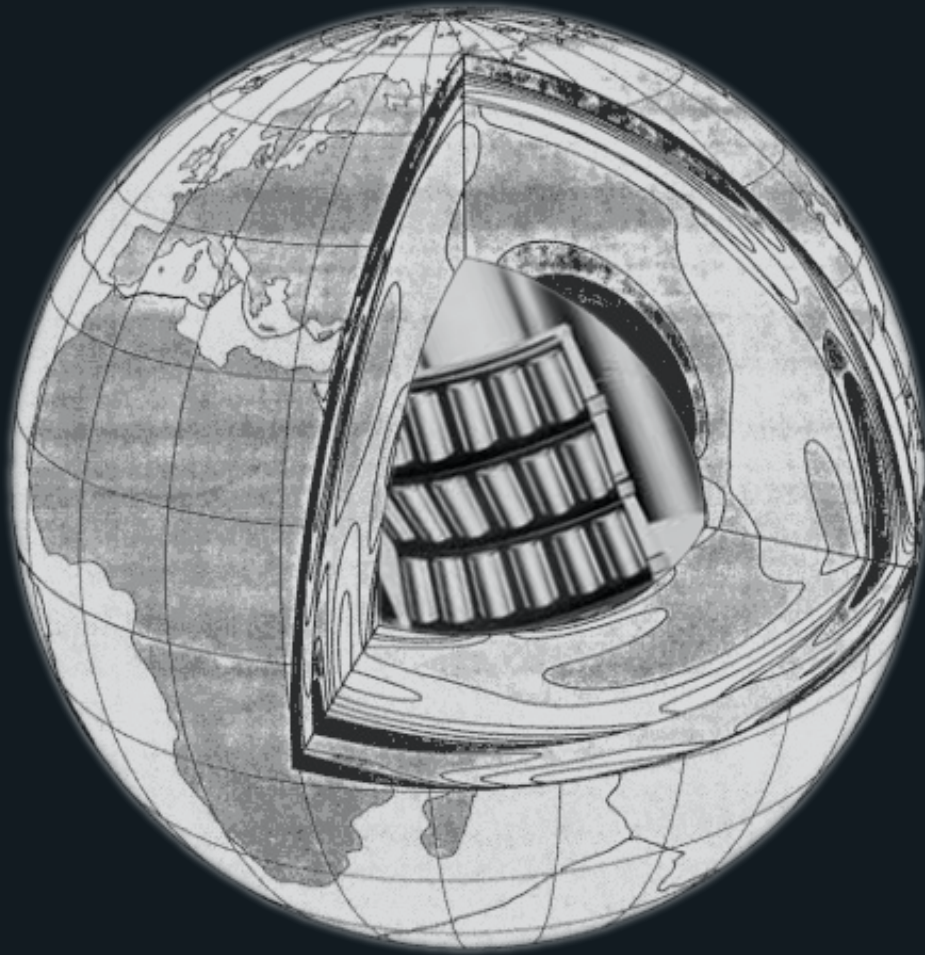

www.foxbearings.eu

OUR LOCATIONS

Eppendorfer Landstrasse 33,
20249 Hamburg, Germany.
Email. sales@foxbearings.eu

Steel Impex & Industries Survey
No.115, Hissa No.6, Ghodbunder
Village Road, Mira Road, India.
Ph: +91 9820086421/9820239477
Email. info@steelimpex.net
